



Operating Manual BMGZ710 and BMGZ710.PNET

Robust evaluation unit for conveyor belt scales, with
optional PROFNET interface

Document Version	3.30	
Published / Author	12/2024	NS
Firmware Version BMGZ710	1.35	
Firmware Version BMGZ710.PNET	1.35	



PROFI[®]
NET



Free download for IOS and Android

**Diese Bedienungsanleitung ist auch in Deutsch erhältlich.
Bitte kontaktieren Sie Ihre nächstgelegene FMS Vertretung.**

1 Table of contents

1	TABLE OF CONTENTS	2
2	SAFETY INSTRUCTIONS	4
2.1	Representations of safety instructions	4
2.1.1	Risk that may result in minor or moderate injury	4
2.1.2	Instructions to ensure proper functionality	4
2.2	General safety instructions	4
3	PRODUCT INFORMATION	5
3.1	System configuration	5
3.2	Product description	5
3.3	Functional description	5
3.4	Scope of delivery	6
3.5	Order code for evaluation unit	6
4	INSTALLATION	7
4.1	Electrical connection (see installation instructions for the FMS measuring roller)	9
5	OPERATION AND SURFACE	12
5.1	Navigation, quick start	12
5.2	Histogram	14
6	CONFIGURATION	15
6.1	Machine parameters	15
6.1.1	Description of machine parameters	15
6.2	Operating parameters	18
6.2.1	Description of operating parameters	19
6.3	System parameters	20
6.3.1	Description of system parameters	21
6.4	Service	22
6.5	Digital inputs	24
6.5.1	Digital input 1 (zero setting)	24
6.5.2	Digital input 2 (batch active)	24
6.5.3	Digital input 3 (belt running)	24
6.5.4	Digital input 4 (impulse)	25
6.6	Digital outputs	26
6.6.1	Digital output 1 (BMGZ OK)	26
6.6.2	Digital output 2 (taring active)	26
6.6.3	Digital output 3 (remote impulse)	26
6.6.4	Digital output 4 (remote reset)	26
7	STANDARD PROCEDURES	27
7.1	Taring (zero setting)	27
7.2	Calibrating	28
7.3	Manual batch weighing	29
7.4	Manual batch weighing – with storage in the alibi protocol	29
8	CONFIGURATION VIA WEB INTERFACE	30
8.1	Peer-to-peer connection	30
8.2	Home screen	33
8.3	Current reading	33
8.4	Parameters	34
8.5	Alibi protocol	35
8.6	Ethernet settings	36
8.7	System settings	36

9	FMS BELTSCALE APP	37
9.1	Configuration via app	38
10	DIMENSIONS	39
11	OPTIONAL ETHERNET INTERFACE – PROFINET	42
11.1	Ethernet Configuration Device – FOR PROFINET DEVICE ONLY	42
11.2	Communication	45
11.2.1	Function	45
11.2.2	Services und Protocols	46
11.3	Cyclic data traffic	46
11.4	Acyclic data traffic	49
12	TECHNICAL DATA BMGZ710	54
12.1	Specification PROFINET interface	54

2 Safety instructions

All safety, operating, and installation instructions given here serve to ensure that the device functions properly. They must be observed in all circumstances to ensure the safe operation of systems. Failure to comply with the safety instructions or use of the devices outside of the specified performance characteristics may endanger the safety and health of persons.

Work relating to the operation, maintenance, conversion, repair, or configuration of the device described may only be performed by qualified personnel.

2.1 Representations of safety instructions

2.1.1 Risk that may result in minor or moderate injury



Danger, warning, caution

Type and source of danger

Possible consequence of disregarding the instruction

Measures to prevent the danger

2.1.2 Instructions to ensure proper functionality



Instruction

Instruction regarding proper operation

Simplification of operation

Ensuring functionality

2.2 General safety instructions



The functionality of the conveyor belt scales is only guaranteed if the components are installed in the recommended configuration. If not, there is a risk of serious malfunction. The installation instructions on the following pages must therefore always be followed.



The on-site installation regulations serve to ensure the safety of electrical systems. These regulations are not taken into consideration by this operating manual. However, they must always be observed nonetheless.



Improper earthing may cause electric shocks to people, malfunctions of the entire system, or damage to the evaluation unit! It must always be ensured that the housing is properly grounded.

3 Product information

3.1 System configuration

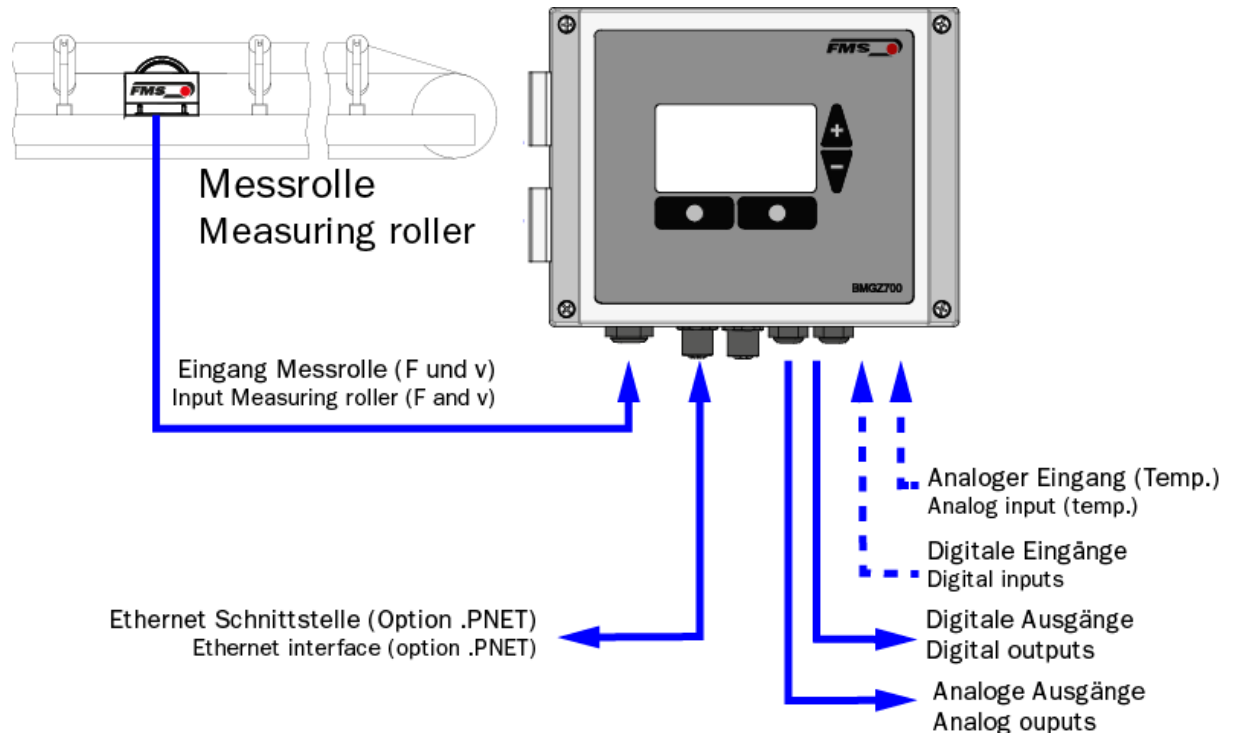

Figure1: Measuring roller and evaluation unit

3.2 Product description

The evaluation units in the BMGZ700 series are designed to meet the demanding conditions of applications in mobile and stationary conveyor systems. The illuminated graphical display shows the current flow rate, the daily amount, the total amount, and the belt speed. Additional display devices and controls can be connected via the configurable analogue and digital outputs. The web browser, included by default, allows the measuring roller to be quickly configured, e.g. with any PC or laptop, or by remote access.

An integrated PROFINET interface is available as option.

3.3 Functional description

The evaluation units in the BMGZ700 series convert the measuring signals from the measuring roller into digital form. The weight of the measuring roller and the load from the belt (taring) are subtracted from the measured value, and the resulting difference is multiplied with the belt speed. The evaluation units in the BMGZ700 series have an auto-taring program that automatically determines the tare value over two belt revolutions by pressing a button.

3.4 Scope of delivery

Included in the delivery:

Evaluation unit; for the .K version, the evaluation unit is preinstalled in the control cabinet

Not included in the delivery:

Power supply unit, installation materials

Also available:

Measuring roller, connection cable from evaluation unit to measuring roller (specify length), M12 d-coded Ethernet cable, or RJ45 patch cable for web browser.

3.5 Order code for evaluation unit

BMGZ710 : Order code	
BMGZ7	1 0 .W Housing (.W wall mount; .S. panel mount; K. in cabinet) Additional functionality (none) Variation (1: Single-channel; 5: calabratable) Series
1	
0	
.W	

Figure2: Order code for evaluation unit

4 Installation

Several versions of the evaluation unit are available.

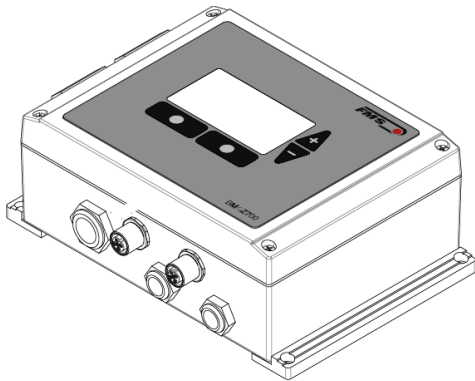

Figure3: BMGZ710.W Wall mount

- Unscrew the 4 screws on the cover with the membrane control panel and display
- The cover can now be opened
- The housing is screwed on through the 4 holes in the bottom of the housing



Figure4: BMGZ710.S Panel mount

The panel must be prepared with a suitable recess and holes. See 9 Dimensions

- The housing is clamped to the sheet metal

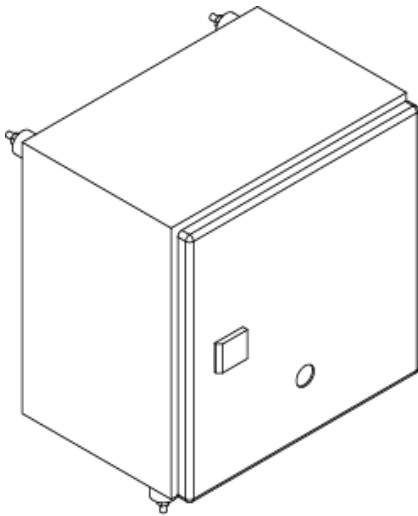

Figure5: BMGZ710.K Cabinet

- The cabinet is screwed on through the 4 holes in the back wall
- Use the rubber mounts if the system experiences vibrations

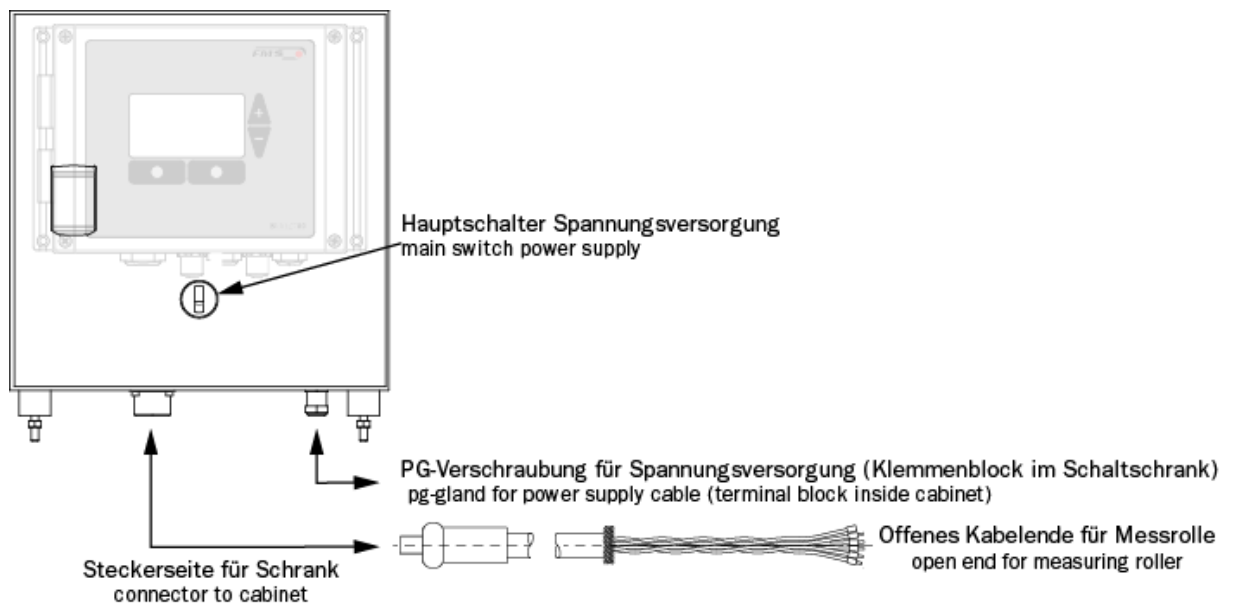

Figure6: Speciality BMGZ710.K

4.1 Electrical connection (see installation instructions for the FMS measuring roller)

The connection between the measuring roller and the evaluation unit must use the 8-core twisted-pair cable (4x2x0.75 mm²) provided.

The cable must be laid away from any power cables to ensure that no interference is induced in the measurement signal. On the measuring roller side, remove the plastic sheath of the cable over a length of approx. 14 cm.

The white wire is not required. Connect the shield to earth terminal.

On the evaluation unit side, remove the plastic sheath over a length of approx. 25-54 cm. The white wire is not required. The shield has to have contact with the pg-gland.

The cable shield must be connected on both sides.

For the K version of the housing (cabinet), feed the cable with the 8-pin plug through the cabinet wall.

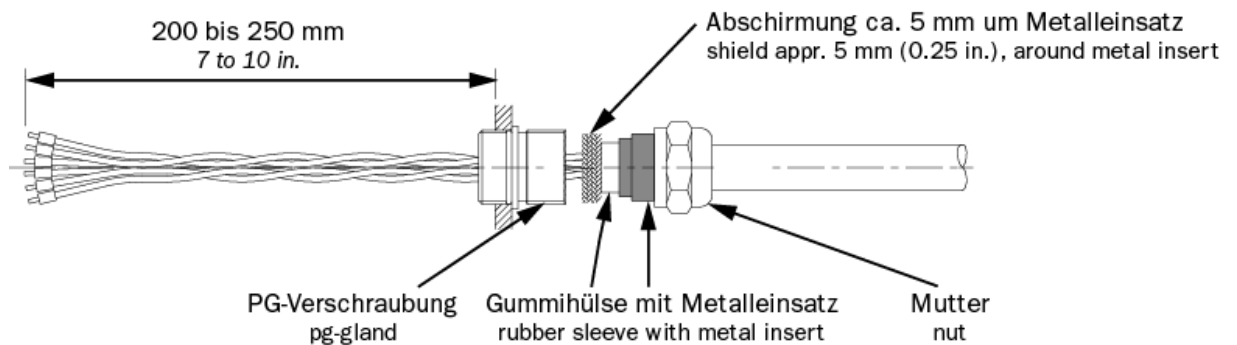

Figure 7: Connection cable, evaluation unit side

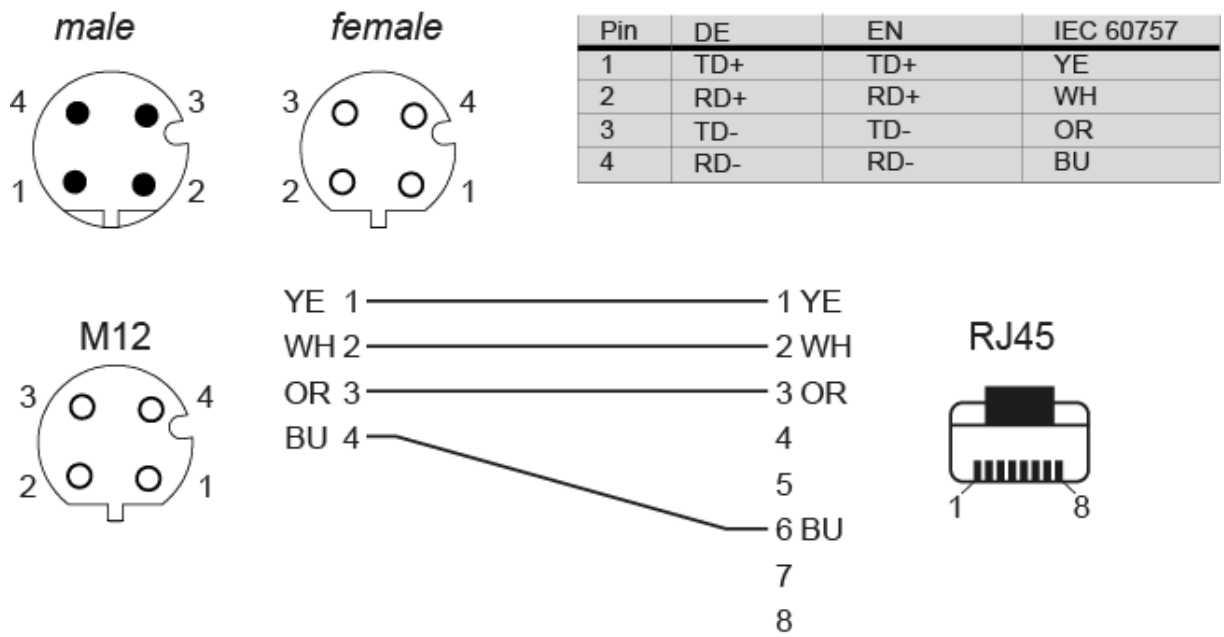

Figure9: ethernet connector M12, D-coded

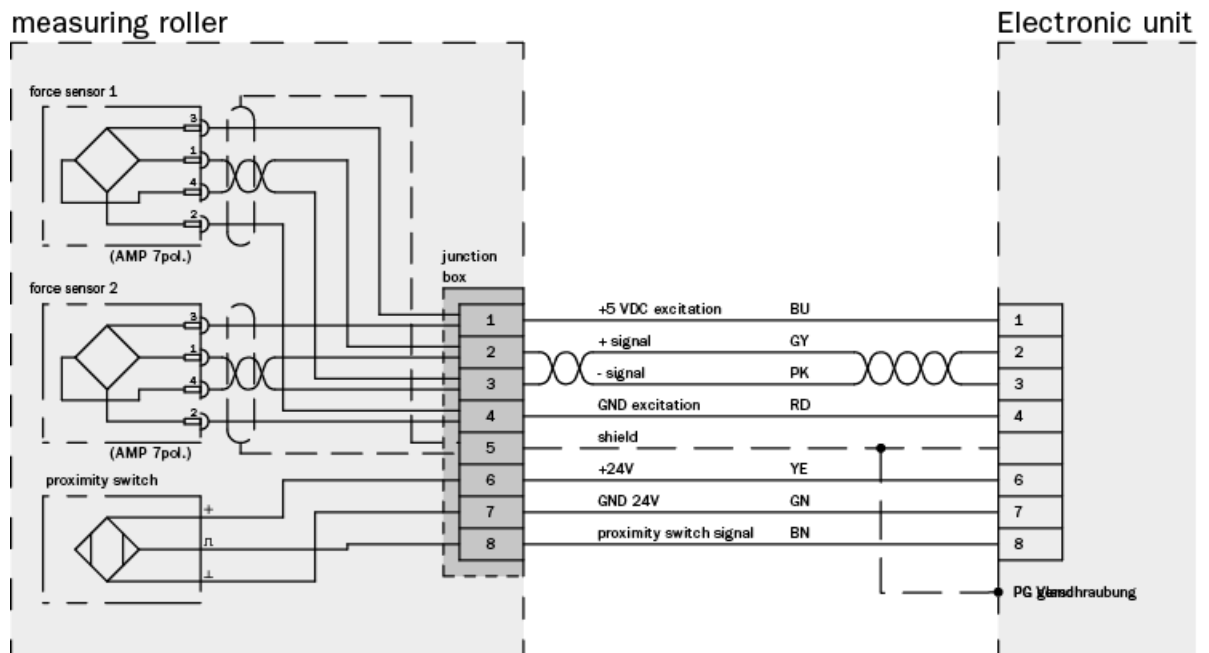

Figure10: Connection cable, measuring roller side

5 Operation and surface

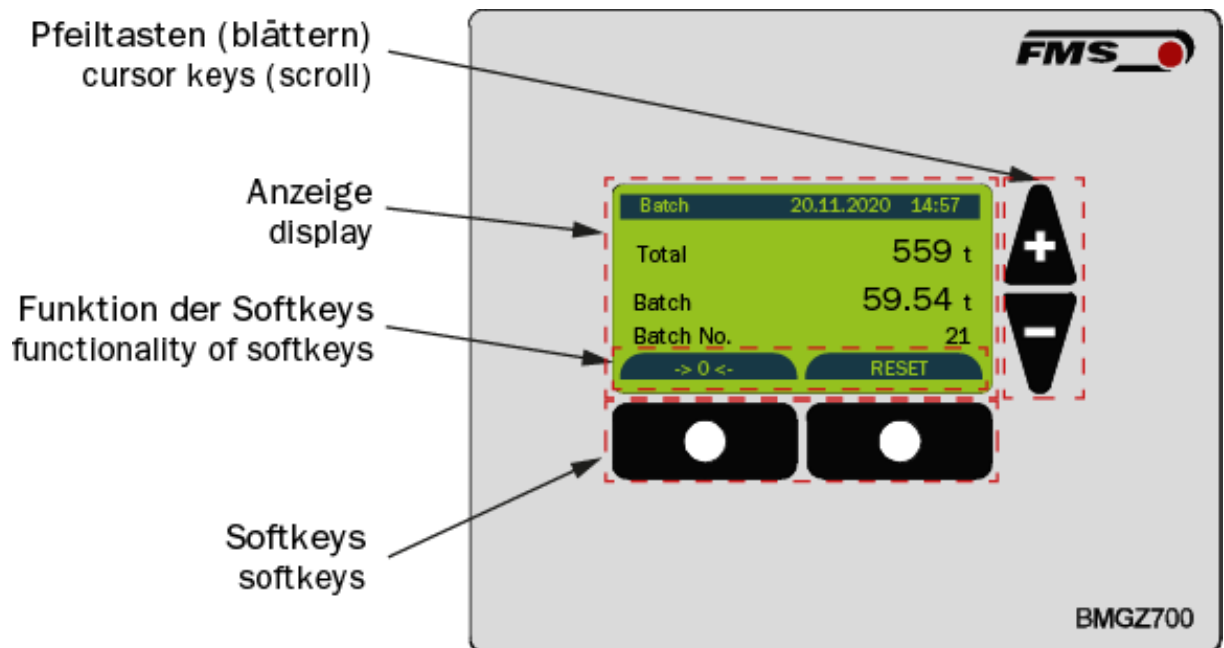



Figure11: View of device

5.1 Navigation, quick start

The menu is divided into two levels

To navigate between levels, use the softkeys (menu) or  

Level 1: HOME

Display current system data with different representations

Level 2: CONFIGURATION

To enter the configuration level, press the softkey (menu) in the Home level

Machine parameters – One-time set-up of conveyor belt and measuring roller

System parameters – Country-specific parameters

Operating parameters – One-time configuration, inputs and outputs

Calibration – Input correction factor

Alibi protocol – Fail-safe storage of batch data

Service – Access to system status and detailed display of error messages

Use the navigation keys   to select individual parameters

To make a selection, press 

Levels, navigation		
Levels	Navigation	Display
HOME		<p style="text-align: center;">Home</p>
		<p style="text-align: center;">Histogram</p>
		<p style="text-align: center;">Zero setting</p>
		<p style="text-align: center;">Batch</p>

		<p style="text-align: center;">Detail</p>
		Press "Menu"
CONFIGURATION		
		Press ←
PARAMETER		

Table 1: levels, display

5.2 Histogram

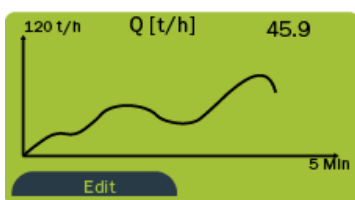

Pressing "Edit" takes you to the configuration of the display.

The "Scaling" parameter allows you to adjust the division of the vertical axis. The "Recording" parameter allows you to set the recording time in the horizontal axis.

6 Configuration

6.1 Machine parameters

The machine parameters directly affect the weighing results.

Machine parameters						
<i>Parameter</i>	<i>Unit</i>	<i>Selection</i>	<i>Default</i>	<i>Min.</i>	<i>Max.</i>	<i>No.</i>
Offset	[Digit]		0	-32768	32767	1
Gain	[-]		1	0.1	10	2
Belt length	[m]		10	1	5000	3
Diameter	[mm]		108	10	1000	4
Pulse	[-]		4	1	100	5
Distance	[mm]		2000	100	5000	6
Nominal force	[N]		1000	1	5000	7
Max. Q	[t/h]		0	1	5000	54
v-detection	-	auto, none	auto			55

Table 1: Machine parameters

6.1.1 Description of machine parameters

Parameter	
<i>Name</i>	<i>Description</i>
Offset	<p>The evaluation unit saves the value determined during taring / zero setting in [Digit].</p> <p>Unit Digit</p> <p>Min. -32768</p> <p>Max. 32768</p> <p>Default 0</p> <p>Increment 1</p>

Parameter	
Name	Description
Gain	<p>The value determined during calibration is saved under this parameter. If the automatic calibration cannot be used, a manually determined value can also be entered here.</p> <p>Unit -</p> <p>Min. 0.100</p> <p>Max. 10.000</p> <p>Default 1.000</p> <p>Increment 0.001</p>
Belt length	<p>The unrolled length of the conveyor belt is saved under this parameter. This value is required for taring.</p> <p>Unit m</p> <p>Min. 1</p> <p>Max. 5000</p> <p>Default 10</p> <p>Increment 1</p>
Diameter	<p>The diameter of the centre roller is saved under this parameter (see measuring roller nameplate).</p> <p>Unit mm</p> <p>Min. 10</p> <p>Max. 1000</p> <p>Default 108</p> <p>Increment 1</p>
Pulse	<p>The number of blades of the pulse generator is stored under this parameter, see measuring roller nameplate. This value corresponds to the number of pulses per revolution of the measuring roller.</p> <p>Unit -</p> <p>Min. 1</p> <p>Max. 100</p> <p>Default 4</p> <p>Increment 1</p>

Parameter	
Name	Description
Distance	<p>The distance between adjacent idlers is saved under this parameter. This value corresponds to the sum of the distances between the measuring roller and the preceding and following idler stations.</p> <p>Unit mm Min. 100 Max. 5000 Default 2000 Increment 1</p>
Nominal force	<p>Nominal force of the force sensors. This value is indicated on the label of the measuring roller and the labels of each force sensor. See measuring roller nameplate.</p> <p>Unit N Min. 1 Max. 5000 Default 1000 Increment 1</p>
Max. Q	<p>The maximum capacity Q of the belt scale can be stored in this parameter.</p> <p>The factory setting "0" has no further effect.</p> <p>If a value other than "0" is set:</p> <p>If the current capacity falls below 5% of this value, the electronics no longer integrates. The measurement "pauses", so to speak, until the delivery rate rises above the 5 % again. Batch counter and totalizer are not increased during this time.</p> <p>Unit t/h Min. 0 Max. 5000 Default 0 Increment 1</p>

Parameter	
Name	Description
v-detection	<p>If this parameter is set to "automatic", the speed of the conveyor belt is recorded with the pulse generator integrated in the measuring roller.</p> <p>If the parameter is set to "none", no speed detection takes place. The capacity is then calculated with a preset belt speed of 1.00 m/s. In addition to this setting, digital input 3 "Belt running" must also be activated.</p> <p>This function is not used in practice, since the automatic speed detection is usually activated. For test purposes, however, this function can be helpful.</p> <p>Unit -</p> <p>Selection none</p> <p> Auto</p> <p>Default Auto</p>

Table 2: Description of machine parameters

6.2 Operating parameters

Operating parameters						
Parameter	Unit	Selection	Default	Min.	Max.	No.
Pulse output	[kg]		100	1	10000	50
Current output		0 to 20; 4 to 20 mA	4 to 20 mA			51
Filter output	[Hz]		10.0	0.1	20.0	52
Scaling	[t/h]		1000.0	1.0	5000.0	53

Table 3: Operating parameters

6.2.1 Description of operating parameters

Operating parameters	
Name	Description
Pulse output	<p>This output emits a pulse each time the defined weight has passed the measuring roller. The weight corresponding to one pulse is stored under this parameter.</p> <p>Pulse duration 1 to 1000 ms, depending on flow rate</p> <p>Unit kg</p> <p>Min. 1</p> <p>Max. 1000</p> <p>Default 100</p> <p>Increment 1</p>
Current output	<p>Two proportional analogue outputs are available for the flow rate.</p> <p>The type of current output signal is selected here.</p> <p>Current and voltage outputs can be used independently.</p> <p>Unit -</p> <p>Selection 0 to 20 mA, 4 to 20 mA</p> <p>Default 4 to 20 mA</p>
Filter output	<p>First-order low-pass filter for the analogue output to filter out undesirable fluctuations.</p> <p>The threshold frequency is configured here.</p> <p>This filter is independent of the other filters.</p> <p>Unit Hz</p> <p>Min. 0.1</p> <p>Max. 20.0</p> <p>Default 10.0</p> <p>Increment 0.1</p>

Operating parameters	
Name	Description
Scaling output	<p>Here, you can define the flow rate that generates the maximum output signal (10 V or 20 mA) at the analogue outputs.</p> <p>The resolution is 12 bits.</p> <p>Unit t/h</p> <p>Min. 1.0</p> <p>Max. 5000.0</p> <p>Default 1000.0</p> <p>Increment 0.1</p>

Table 4: Description of operating parameters

6.3 System parameters

System parameters						
Parameter	Unit	Selection	Default	Min.	Max.	No.
Language	-	German, English	German			1
Filter display	Hz		1.0	0.1	1.0	2
Date format	-	DD.MM.Y YYY, MM.DD.Y YYY	DD.MM.YYYY			3
Time / date	-			00:00 01.01.202 0	23:59 31.12.2099	4
IP address	-		192.168.0.90	0	255	5
Subnet mask	-		255.255.255.0	0	255	6

Table 5: System parameters

6.3.1 Description of system parameters





System parameters	
Name	Description
Language	<p>This parameter allows the display language to be selected. Either German or English can be selected.</p> <p>Unit -</p> <p>Selection German, English</p> <p>Default German</p>
Filter display	<p>First-order low-pass filter to filter out undesirable fluctuations from the display. The threshold frequency of the filter is configured here.</p> <p>Unit Hz</p> <p>Min. 0.1</p> <p>Max. 10</p> <p>Default 1.0</p> <p>Increment 0.1</p>
Date format	<p>Here, the format of the displayed date can be configured.</p> <p>Unit -</p> <p>Default DD.MM.YYYY</p> <p>Increment DD.MM.YYYY, MM.DD.YYYY</p>
Time / date	<p>The evaluation unit has a built-in real-time clock (RTC). To configure the time, the current time and date can be entered into this parameter.</p> <p>This information is stored in the alibi memory with the corresponding batch.</p> <p>There is NO automatic compensation of summer and winter time</p> <p>Unit -</p> <p>Min. 00:00 01.01.2020</p> <p>Max. 23:59 31.12.2099</p>

System parameters	
Name	Description
IP address	Static IP address of the evaluation unit The IP address is entered in four blocks. Note: This IP-address is NOT relevant for PROFINET! Unit - Min. 0 Max. 255 Default 192.168.0.90
Subnet mask	The subnet mask is entered in four blocks. Unit - Min. 0 Max. 255 Default 255.255.255.0

Table 6: Description of system parameters

6.4 Service

Service		
Parameter	Unit	Display
A/D values raw	Digit	Raw value
DMS raw	mV	Raw value
Travel	mV	Raw value minus offset
Force	N	Calculated
Belt	kg/m	Weight
Digital inputs:	-	Status: 0 = inactive; 1 = active Taring Batch active Belt is running Impulse
Digital outputs		Status: 0 = inactive; 1 = active BMGZ ok Zero setting active Remote impulse

		Remote reset
Error code		<p>0 no error</p> <p>1 Measuring roller overloaded Check measuring roller cable. Check for short circuit → strain gauge input (ADC) is over limit (> +/- 32000 Digits) → reduce load on measuring roller.</p> <p>2 Analog output overloaded Q [t/h] > scaling >10V or >20mA. Check scaling The analog output (DAC) is limited (> 4095 Digits), which would lead to more than 10V or 20mA. → check scaling</p> <p>3 Analog output < minimum Q [t/h] < 0 <0V or <0/4mA Check Zeroing The analog output (DAC) shows 0 Digits. There is a small hysteresis that as Q < -0.2 to indicate the error. → start zero setting or adjust offset manually.</p> <p>4 Impulse output too fast. The impulse output is no longer correct. The load is higher that the output can indicate. → Reduce load or enhance the parameter of the impulse output [kg] so that more weight per pulse can be outputted.</p>
Device offset		<p>Factory setting: Please do not change!</p> <p>Can be changed in case of replacement or repair.</p> <p>Press and hold the  and  keys simultaneously for > 5 sec. to access this parameter.</p>
Device gain		<p>Factory setting: Please do not change!</p> <p>Can be changed in case of replacement or repair.</p> <p>Press and hold the  and  keys simultaneously for > 5 sec. to access this</p>

		parameter.
Totalizer		<p>Can be changed in case of replacement or repair.</p> <p>Press and hold the ← and  keys simultaneously for > 5 sec. to access this parameter.</p>

Table 2: Service

6.5 Digital inputs

The functions of the digital inputs are preconfigured and cannot be changed.

6.5.1 Digital input 1 (zero setting)

Setting this input begins the procedure for zero setting. Setting the input to inactive aborts the ongoing procedure.

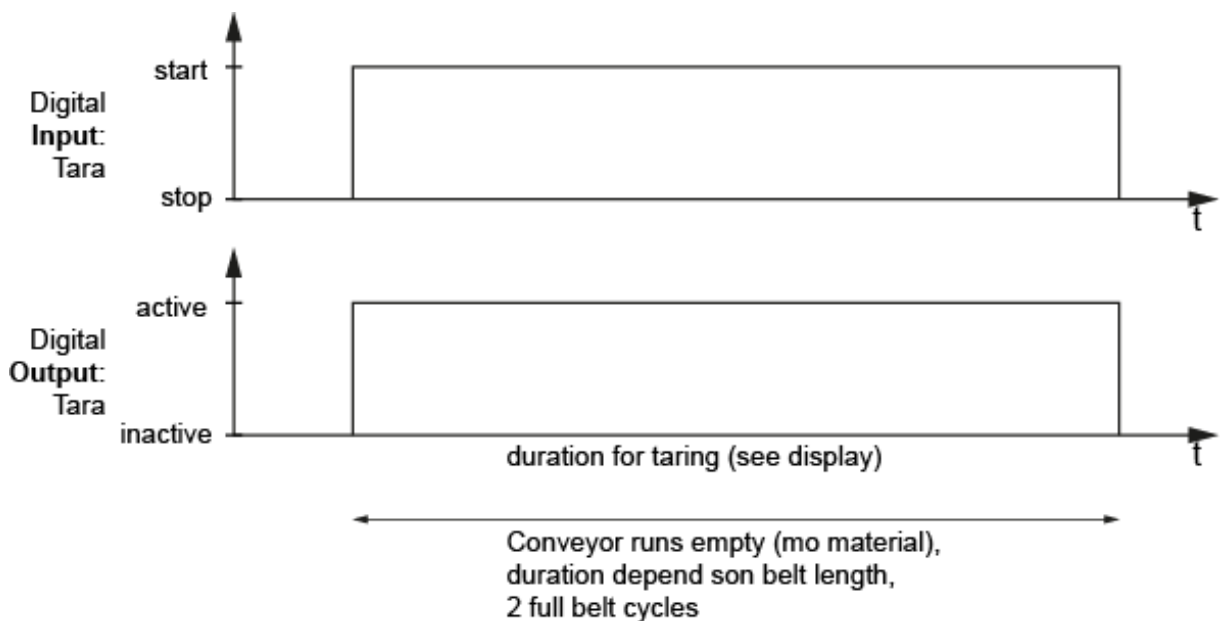

Figure 12: context dig. in- and output

6.5.2 Digital input 2 (batch active)

Setting this input starts the weighing of a new batch. The batch counter is incremented, and the batch weight is set to zero.

If the digital input 'Batch active' is set, the batch counter (quantity) is zeroed (identical to when the Reset softkey is pressed) and the batch no. is increased by 1. While this input is active, a batch is weighed. If the input becomes passive, the batch no., the weighed quantity (batch counter), date and time are saved in the alibi protocol. This ensures that weighed batches are traceable.

6.5.3 Digital input 3 (belt running)



Note

This setting is only relevant if v-detection is set to "None".

If the v-detection parameter is set to 'None', the evaluation electronics does not calculate the speed using the initiator information but takes 1.00 m/s as the belt speed value for the calculation. However, the evaluation electronics only integrates the weight if this digital input 3 "Belt running" is active, otherwise not.

6.5.4 Digital input 4 (impulse)

The status of the proximity switch for detecting the speed is displayed here.

6.6 Digital outputs

The functions of the digital outputs are pre-configured and cannot be changed.

6.6.1 Digital output 1 (BMGZ OK)

24 VDC, max. 100 mA

This output is always “active” if the evaluation unit is switched on and there is no error. Any error deactivates the output (e.g. “belt not running”, “negative flow rate”, or “overload”). An error message is also shown on the display.

6.6.2 Digital output 2 (taring active)

24 VDC, max. 100 mA

If taring (zero setting) has been started, this output is activated until the procedure is completed or cancelled. As long as the output is active, no material shall be fed over the conveyor.

See 7.1 Taring (zero setting)

6.6.3 Digital output 3 (remote impulse)

24 VDC, max. 100 mA, pulse duration 1 to 1000 ms, depending on the flow rate.

A pulse is emitted on this output above a certain flow rate. The flow rate is defined in the “pulse output” operating parameter.

The pulse can for example be used for a remote counter or as a PLC input.

The pulse duration is symmetric (duty cycle 50%)

6.6.4 Digital output 4 (remote reset)

24 VDC, max. 100 mA, 100 ms

Activation resets the remote counter to zero.

This can also be performed directly through the controls on the device via “Reset” batch.

If the “Reset” softkey is pressed and confirmed with the “Yes” softkey, the batch counter is deleted, and a pulse is emitted on the “remote counter reset” digital output for 100 ms. This allows a remote counter to also be reset to zero, for example.

7 Standard procedures

7.1 Taring (zero setting)

Taring ensures that no weight is integrated when the belt is idling to avoid weighing errors. The weight of the belt and the measuring roller are subtracted from the measurement.

The “taring” procedure can be started via the “taring” digital input or on the home screen via “→0←”.

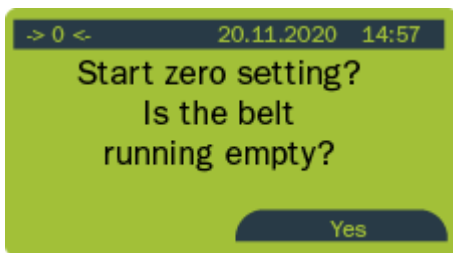

Figure13: Taring home screen

The taring procedure calculates the taring time from the “belt length” parameter and the speed and ensures that the A/D value is determined, averaged, and the offset value calculated over two belt revolutions. This value is then saved under the “Offset” parameter.

To do this, proceed as follows:

- Switch to the “→0←” screen
- Start the conveyor belt without any load
- Start the procedure by pressing the “Yes” softkey
- The remaining time is shown on the display. The procedure can be stopped at any time by pressing the “Cancel” softkey.
- When the procedure is stopped, the newly calculated offset value is displayed and saved under the “Offset” parameter.

Multiple taring throughout the day

The belt tension directly affects the measurement results.



Strong temperature variations throughout the day will affect the belt tension, which will be directly reflected in the measurement results.

Check the belt tension regularly, and perform taring in the morning and early afternoon, for example.

Measurement accuracy



Errors or inaccurate work during taring and calibration will directly affect the accuracy of the conveyor belt scales.

Ensure that taring is performed carefully.

Setting the “taring” digital input begins the recalculation of the offset. The “taring active” digital output is set until the procedure is completed or aborted. If the “taring” input is reset before the remaining time has elapsed, the procedure is aborted, the “taring active” digital output is reset, and the offset value is not changed.

7.2 Calibrating

The belt scale must be calibrated at start-up to ensure that the evaluation unit can correctly calculate the flow rate.

- Run the conveyor belt while empty
- Press “Reset” on the home screen
- The batch amount is set to 0 t and the batch counter is incremented by 1.
- Load batch onto truck with known tare weight.
- Stop conveyor
- Weigh truck on platform or truck scale
- Compare the currently displayed batch quantity with the actual weight as weighed on the truck
- To adjust, select the menu item “Calibration” in the configuration (menu)

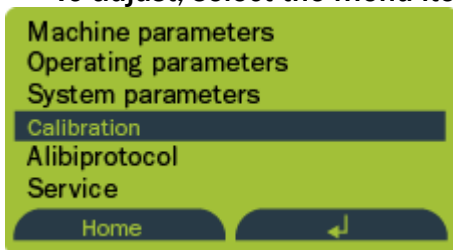



Figure14: Calibration

- Pressing  activates the input
- You can use the cursor keys to enter the actual weighed quantity under “Reference value”.
- Press “Calculate”
- The display will show: “Calibration complete”. The newly calculated gain factor “Gain” will be displayed and will be saved in the background under the “Gain” parameter.



Measurement accuracy

Errors or inaccurate work during taring and calibration will directly affect the accuracy of the conveyor belt scales.

Ensure that taring is performed carefully.

7.3 Manual batch weighing

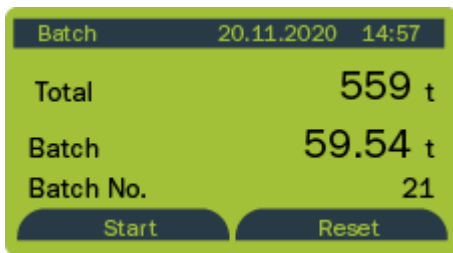

Figure15: Manual weighing of a batch

- Start the conveyor belt without any load
- Press the "Reset" softkey on the home screen
- The batch amount is set to zero
- The batch counter is incremented
- Run the desired amount over the conveyor system.
- End loading and run the belt empty.
- The display will now show the quantity that has just been conveyed under "Batch"

7.4 Manual batch weighing – with storage in the alibi protocol

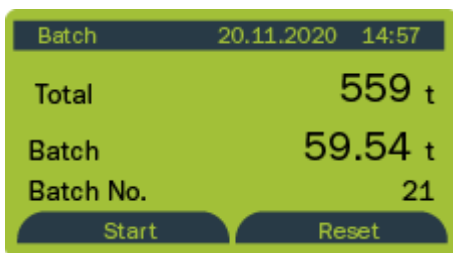

Figure16: Manual batch weighing with storage in the alibi protocol

- Start the conveyor belt without any load
- Press the "Start" softkey on the "Batch" home screen
- The batch amount is set to zero
- The batch counter is incremented
- Run the desired amount over the conveyor system.
- End loading and run the belt empty
- The display will now show the quantity that has just been conveyed under "Batch"
- To end the batch, press the "Stop" softkey.

After the measurement is complete, the values (start time, end time, batch amount, and batch number) are automatically and securely saved in the so-called alibi protocol.

You can retrieve data from the alibi protocol via the web browser or in the configuration under the "Alibi protocol" menu item.

8 Configuration via web interface

IP-Adress for PROFINET



With the PROFINET version, the system parameter IP-adress CAN NOT be used for communication via the web browser.

With the PROFINET version, you have to use the (from the PLC) assigned IP-address. Or you have to assign a unique IP-address via the Ethernet Device Configuration Tool, see 11.1 Ethernet Configuration Device – FOR PROFINET DEVICE ONLY

You can configure the evaluation unit using a web browser (Internet Explorer 7 or higher). To do this, either connect the web guiding controller to an Ethernet network or connect it directly to a PC.

The browser interface is only available in English.

Press “Save changes” to save any modifications, or they will be lost.

8.1 Peer-to-peer connection

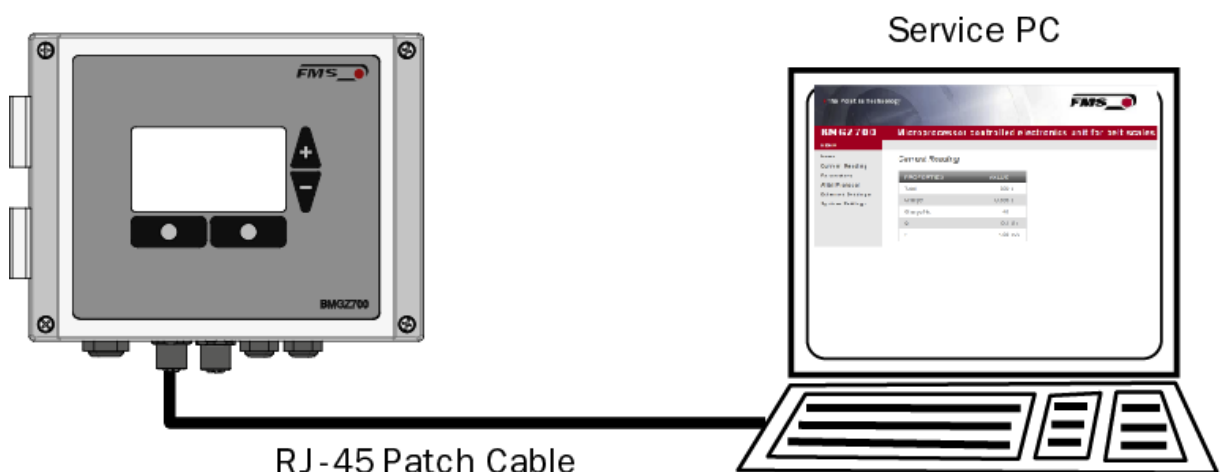

Illustration 17: Peer-to-peer connection

Before you connect the computer to the evaluation unit with the patch cable, you must assign a static IP address to your PC. The two devices can then communicate via web browser.

If the web guiding controller is already connected to a network (e.g. LAN) via a switch, you can skip the following instructions.

Settings for MS Windows 7:

- Connect the PC and evaluation unit with a patch cable
- Start up the PC and evaluation unit
- Click the start button on the PC (bottom left corner of screen)
- Click on “Control Panel”
- Double-click on LAN connection

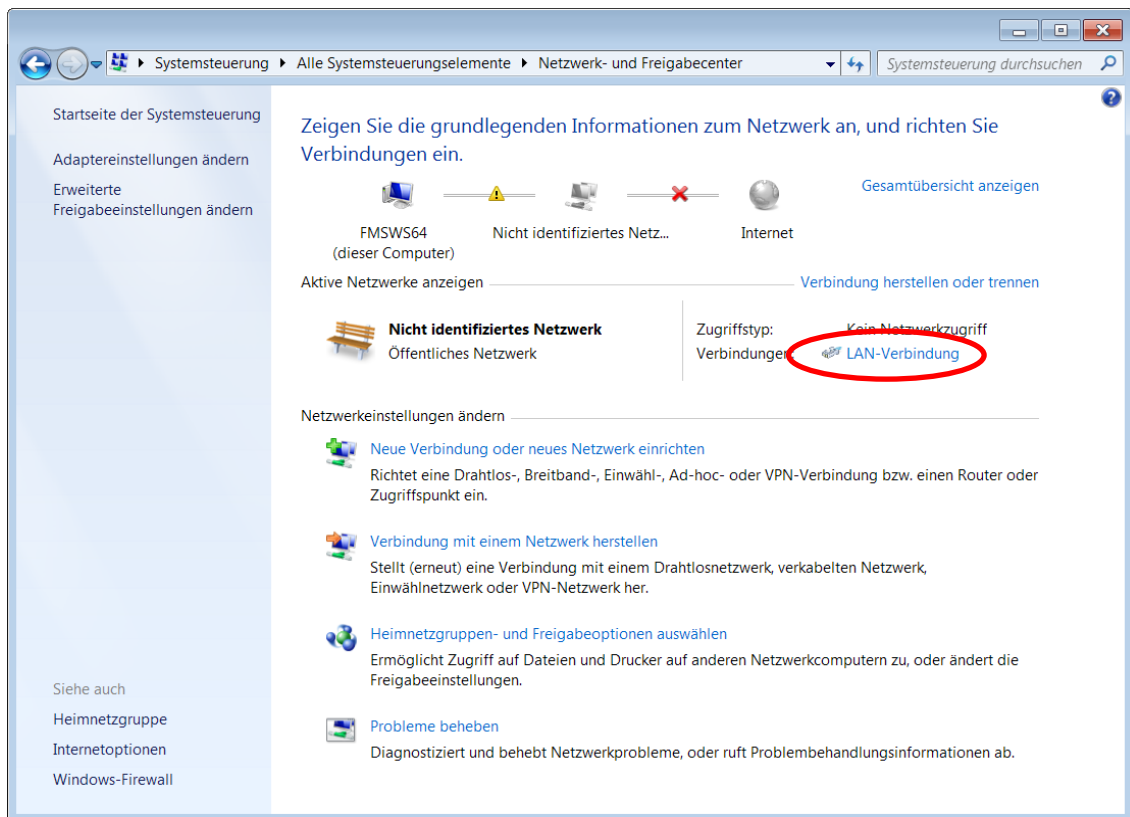

Figure18: Status of LAN connection

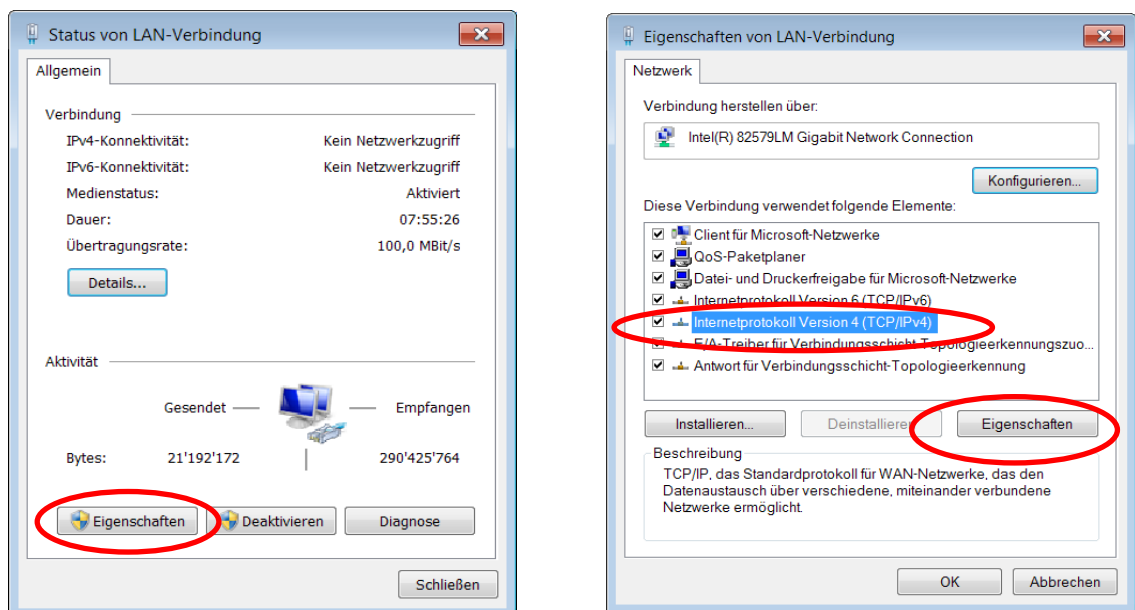

Figure19: Status of LAN connection

- Select "Properties"
- The "Local Area Connection Properties" window will open
- Select "Internet Protocol Version 4 (TCP/IPv4)".

- Select “Properties”. The corresponding window will open.

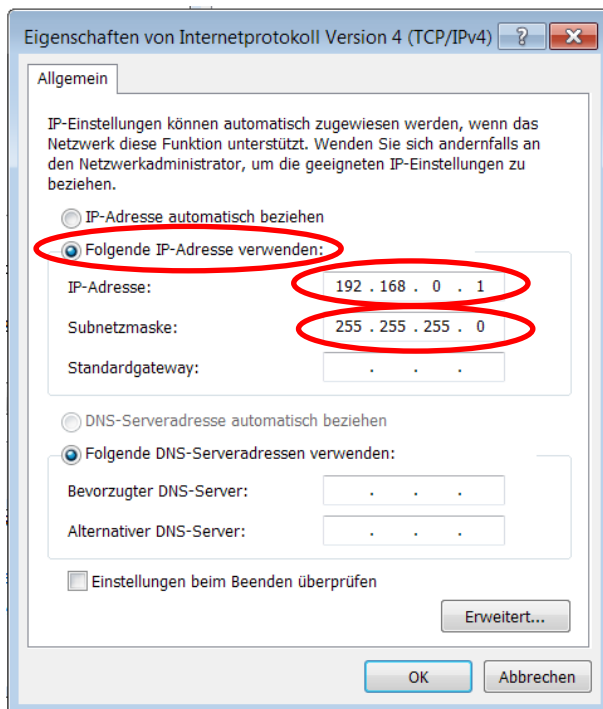

Figure20: Internet protocol properties

- Select “Use the following IP address:”
- Enter the PC address (e.g. 192.168.000.1)
- In the subnet mask, enter: 255 255 255 000
- Close the window with “OK”.
- Close all other windows

The computer is now ready to communicate with the evaluation unit:

- Open a web browser (Microsoft Internet Explorer, Mozilla Firefox, etc.)
- The factory default setting of the IP address of the evaluation unit is 192.168.000.090.
- Enter this IP address in the format 192.168.0.90 into the input field and confirm with “Enter”.
- The home screen will open.

8.2 Home screen

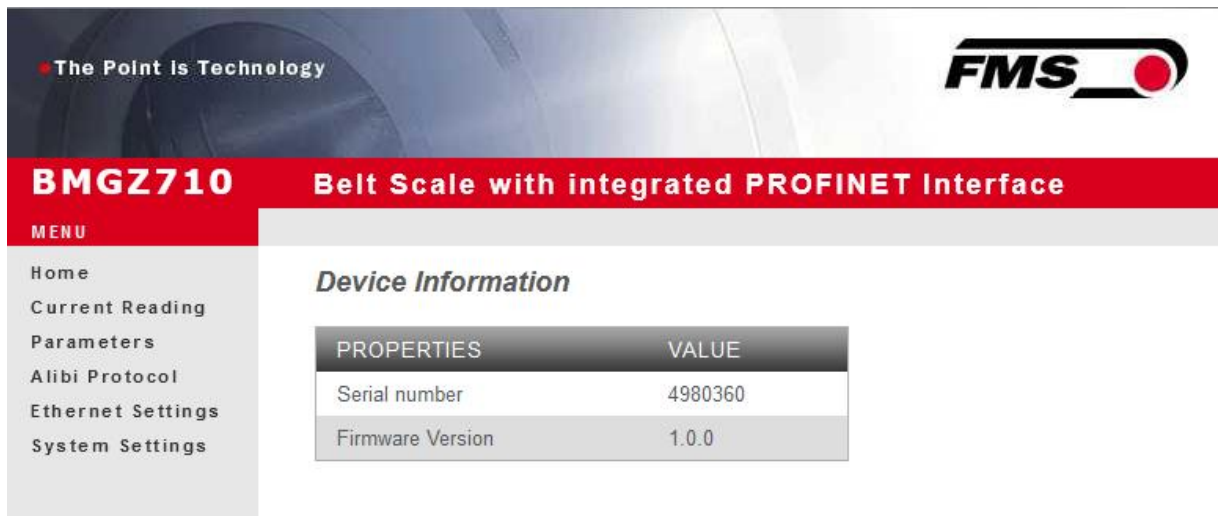

Figure21: Home screen with device information

The home page gives information about general device properties, such as the serial number and software version.

The menu on the left side of the screen allows you to navigate on the page.

8.3 Current reading

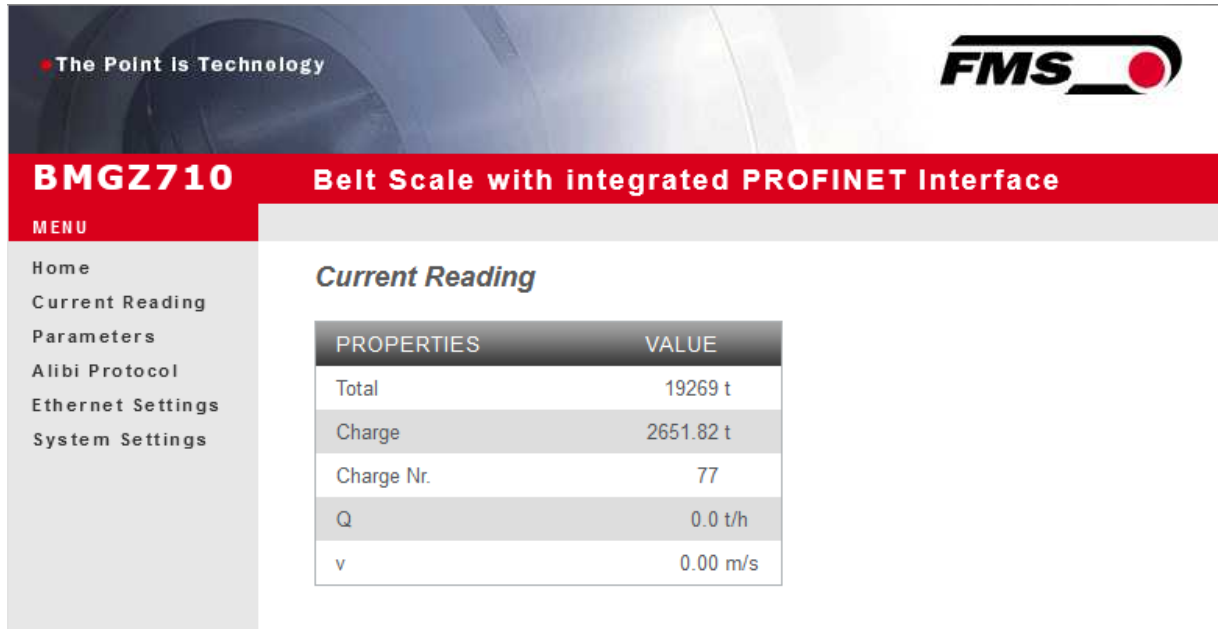

Figure22: Current reading

The current reading webpage shows all current values

8.4 Parameters

The parameters page allows you to modify the parameters.

In PROFINET environments, this is usually done from the PLC.

Parameters

MACHINE	
PROPERTIES	VALUE
Offset	5194
Gain	1.000
Band length	10 m
Diameter	108 mm
Impulses	4
Distance	2000 mm
Nominal Force	1000 N
Max. Q	0 t/h
v-acquisition	Auto

OPERATING	
PROPERTIES	VALUE
Impulse output	1000 kg
Current output	4..20mA
Filter frequency output	10.0 Hz
Scaling output	1000.0 t/h

SYSTEM	
PROPERTIES	VALUE
Display language	Deutsch
Display filter	1.0 Hz
Date format	DD.MM.YYYY
Recording time	3 Min
Histogram scaling	100 t/h

DIAGRAM	
PROPERTIES	VALUE
Recording time	3 Min
Histogram scaling	100 t/h

Figure23: Parameters

Press “Save changes” to save any modifications, or they will be lost.

8.5 Alibi protocol

The screenshot shows the web interface for the BMGZ710 Belt Scale. The header includes 'The Point Is Technology' and the 'FMS' logo. Below the header, the title 'BMGZ710 Belt Scale with integrated PROFINET Interface' is displayed. A left-hand menu lists options: Home, Current Reading, Parameters, Alibi Protocol, Ethernet Settings, and System Settings. The main content area is titled 'Alibi Memory' and contains a table with the following data:

INDEX	START	END	CHARGE NR	CHARGE	TOTAL	MODE
77	03.06.2021 16:42:56	14.12.2021 20:03:11	77	0t	0t	255
76	03.06.2021 15:38:00	03.06.2021 15:39:19	76	3.525 t	16607 t	0
75	03.06.2021 16:31:49	03.06.2021 16:33:43	75	8.001 t	16596 t	0
74	03.06.2021 11:49:01	03.06.2021 11:49:11	75	0.000 t	16499 t	0
73	01.06.2021 13:36:52	01.06.2021 13:38:31	74	4.459 t	16177 t	0
72	20.05.2021 09:57:53	30.11.2021 14:18:08	77	0t	0t	255
71	20.05.2021 09:57:07	20.05.2021 09:57:20	76	0.000 t	4160 t	0
70	20.05.2021 09:54:53	20.05.2021 09:54:56	75	0.000 t	4160 t	0
69	20.05.2021 09:54:50	20.05.2021 09:54:50	74	0.000 t	4160 t	0
68	11.05.2021 11:47:16	11.05.2021 11:48:16	73	2.011 t	1593 t	0

Below the table is a navigation bar with buttons for first, previous, and next, and a dropdown menu currently showing '77'.

Figure24: Alibi protocol

Index – consecutive numbering

Start – start time and date of the batch measurement

End – end time and date of the batch measurement

Batch no. – saved batch number; missing batch numbers correspond to measurements made with “Reset” that were not saved in the alibi protocol.

Batch – batch amount

Total – value of totalizer at the end time

Mode – validity of measurement; invalid measurements are shown crossed out.

8.6 Ethernet settings

BMGZ710 Belt Scale with integrated PROFINET Interface

MENU

- Home
- Current Reading
- Parameters
- Alibi Protocol
- Ethernet Settings**
- System Settings

Ethernet Settings

PROPERTIES	VALUE
MAC Address	00-02-a2-4b-fe-85
Device IP address	192.168.0.84
Subnet Mask	255.255.255.0
Gateway IP address	192.168.0.1

Note: Saving of new settings causes an immediate reset and must be validated within a period of 3 min.

Figure25: Ethernet settings

8.7 System settings

The internal firmware version can be seen on the system settings page. New firmware can also be loaded here.

BMGZ710 Belt Scale with integrated PROFINET Interface

MENU

- Home
- Current Reading
- Parameters
- Alibi Protocol
- Ethernet Settings
- System Settings**

System Settings

PROPERTIES	VALUE
Firmware Version	1.0.0
PROFINET Stack	4.5.0.3
netX Bootloader	1.6.0.1
Program File	<input type="button" value="Durchsuchen..."/> Keine Datei ausgewählt.
Password	<input type="text"/>

Note: Please contact your local FMS office for the password.

Figure26: System settings

The latest firmware files can be found in the download section of our website.

9 FMS BeltSCALE App

The app allows you to read the current measured values and configure the evaluation electronics via your smartphone or tablet.

The devices communicate via an integrated Bluetooth® module.

For clear identification, the last 4 digits of the serial number of the BMGZ700 series are applied to the front of the housing.



Figure27: BMGZ700-series with last 4 digits of the serial number

Only one mobile device can access the evaluation electronics at a time.

As soon as the connection to the mobile device is established, the display of the evaluation electronics flashes.

The FMS BeltSCALE app is an operating aid. No data is saved on the mobile device, only the current measured values of the evaluation electronics and the settings are displayed. The parameters are only saved in the evaluation electronics themselves.



Figure28: Link to download the app (Android or IOS)

9.1 Configuration via app

The procedure for taring and calibration is always identical to the procedure for evaluation electronics without Bluetooth communication. The only difference is that a mobile device is used for input instead of the control panel.

<p>Download the FMS BeltSCALE app and install it → Google Play Store (Android); iTunes (IOS)</p>	<p>Overview of all devices in the reception area Select device, identification by serial number</p>	<p>Display of the current measured values, main menu at the bottom, configuration menu at the top right (password 3231)</p>	<p>Configuration, overview of parameters</p>
<p>Configuration - Overview of machine parameters</p>	<p>Taring</p>	<p>Graphic recording, also possible in landscape format</p>	

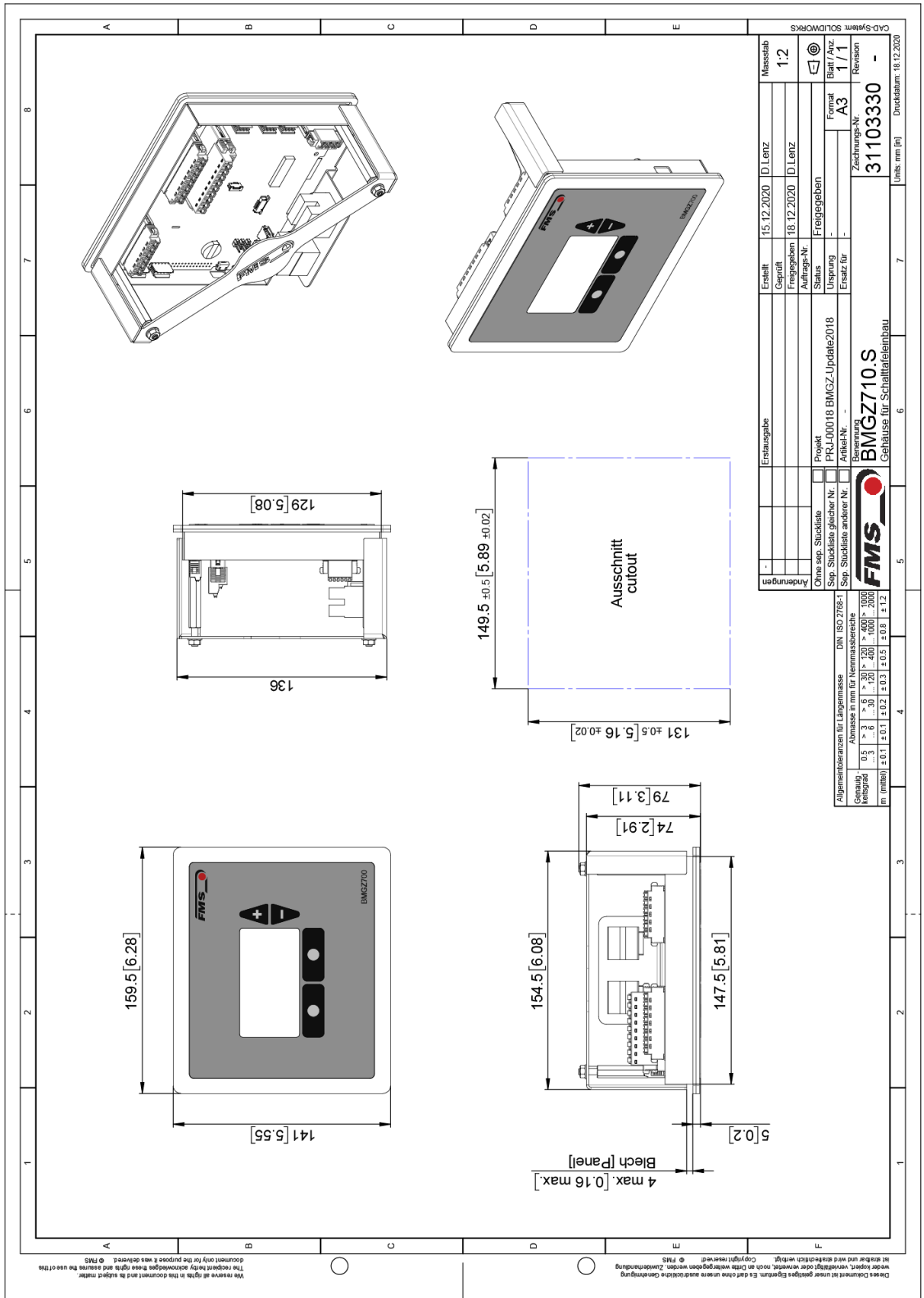

Figure30: Dimensions BMGZ710.S

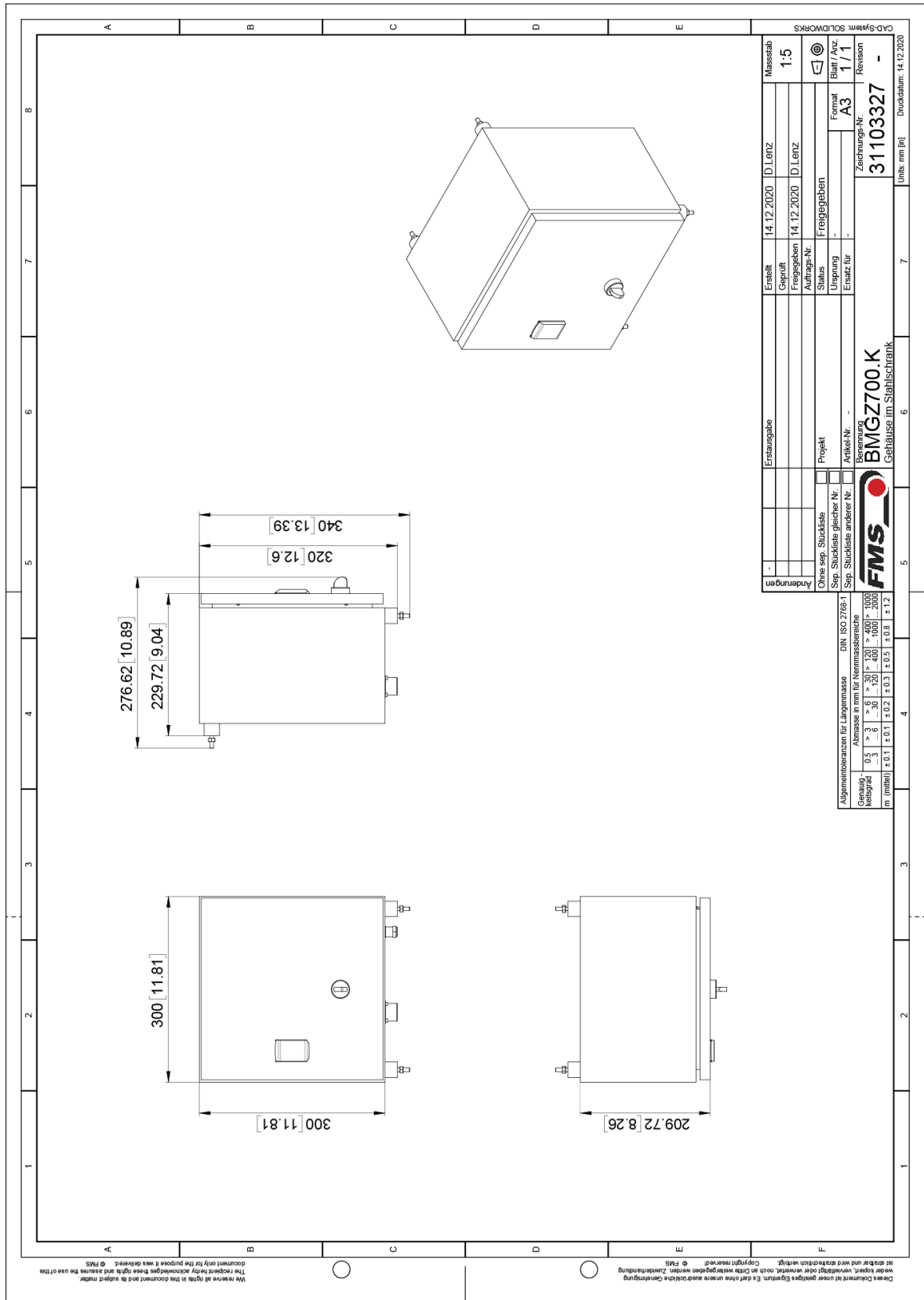

Figure31: Dimensions BMGZ710.K

11 Optional ethernet interface – PROFINET

A PROFINET interface is available for the electronics of the BMGZ700 series with the option .PNET.

BMGZ710.PNET

BMGZ750.PNET – calibratable version, see separate operating manual

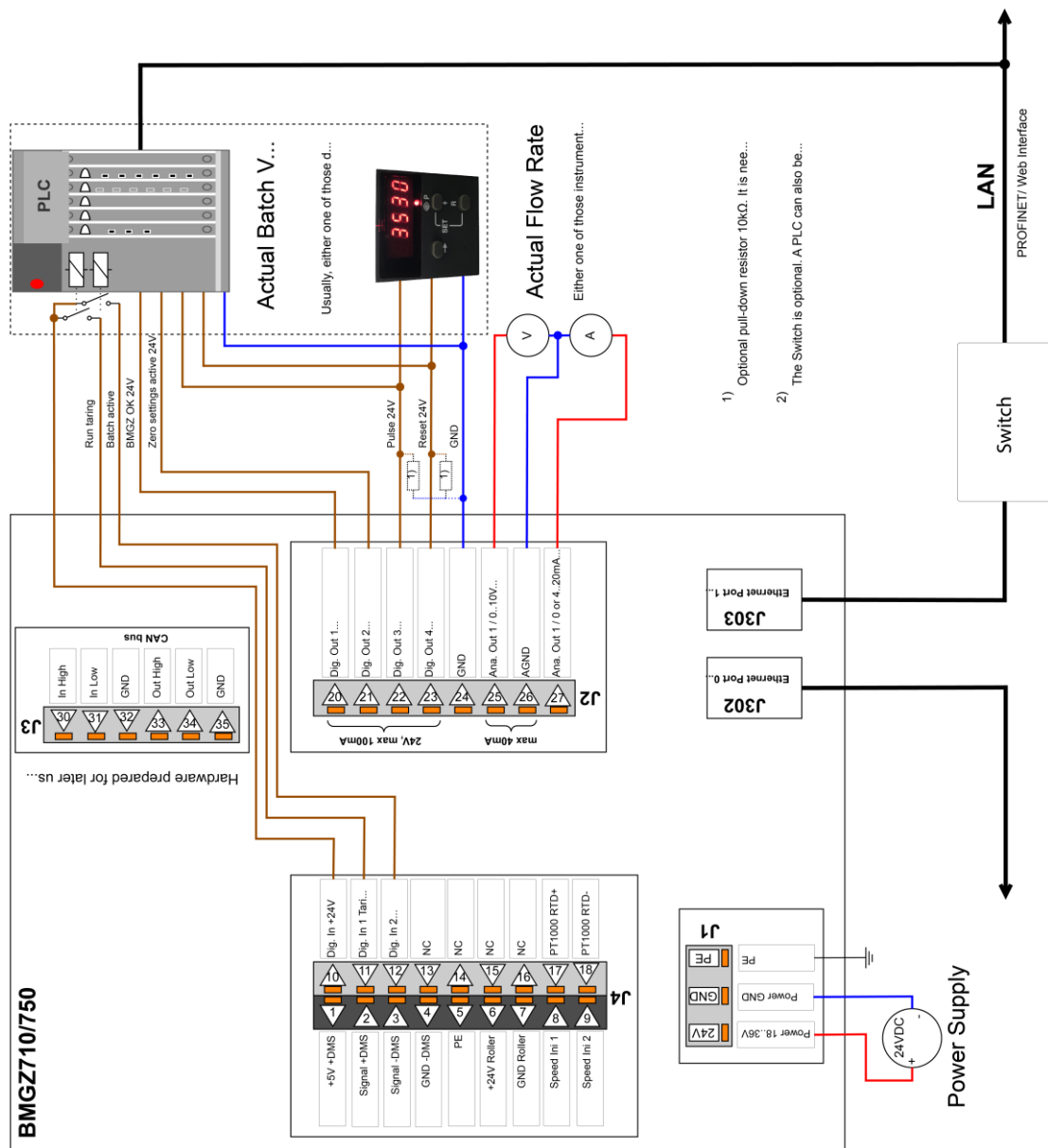

Figure 32: peripheral devices

11.1 Ethernet Configuration Device – FOR PROFINET DEVICE ONLY

The IP address of the measuring amplifier is preset to 0.0.0.0. To modify the address, you can use the «Ethernet Device Configuration Tool». It is available for free download on <https://www.fms-technology.com/en/downloadcenter/profinet>

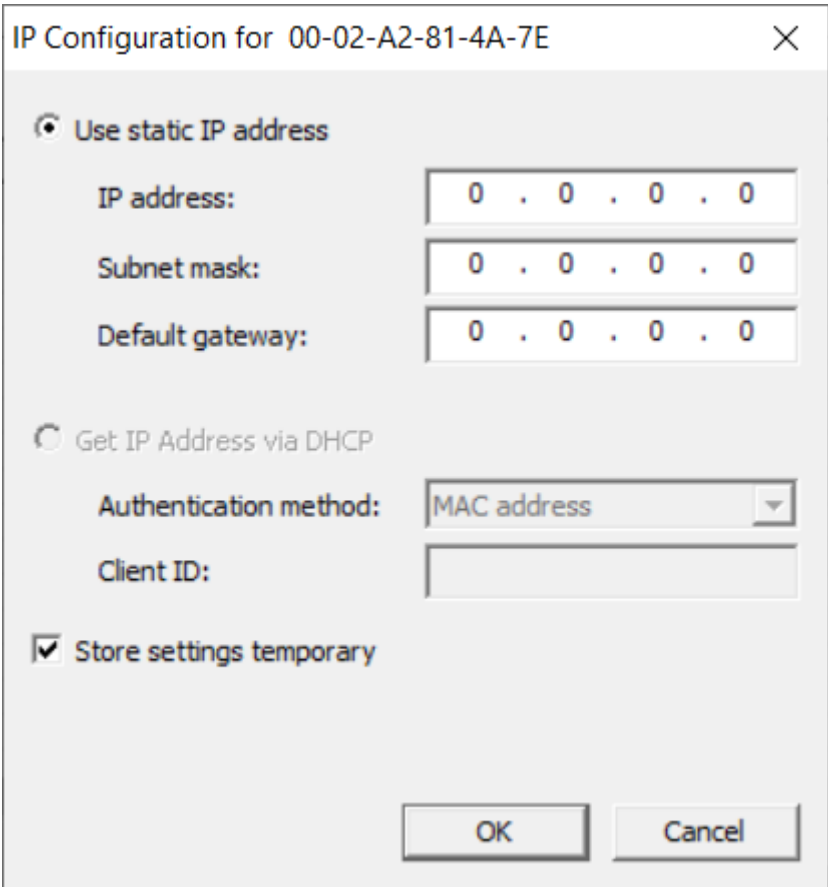

Figure 3: Ethernet Device Configuration – IP Configuration

Enter the desired IP address and also set the subnet mask to 255.255.255.0

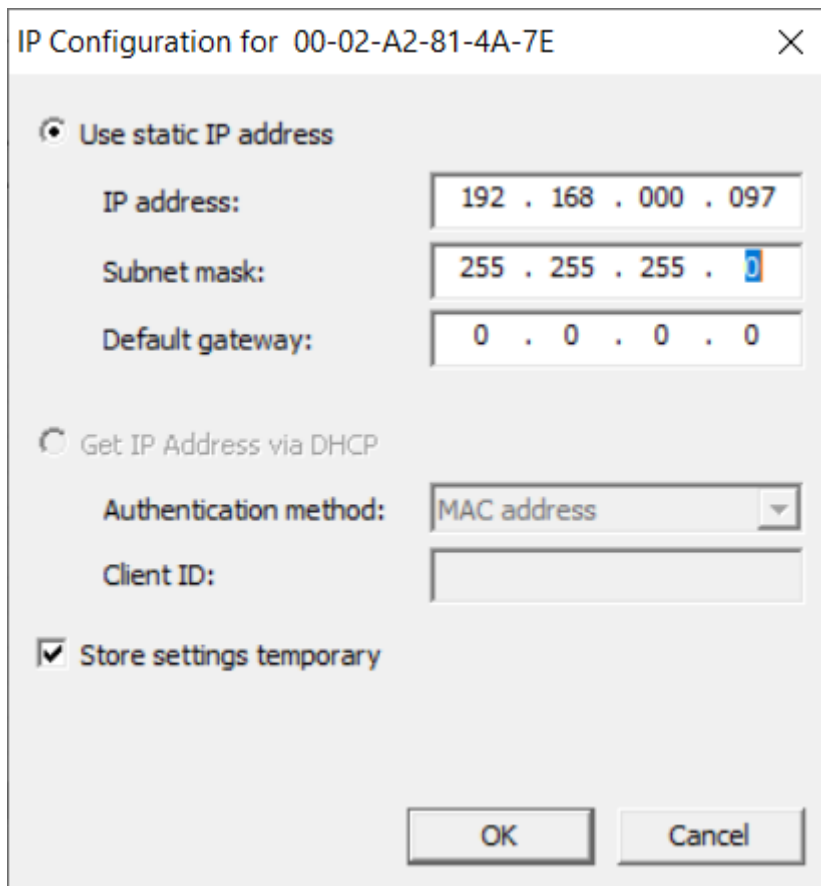

Figure 4: Ethernet Device Configuration – IP Adresse geändert
Press «OK» to store the settings.

11.2 Communication

With the acyclic data exchange, IO devices (slaves) can be parameterized, configured or status information can be read out. This is accomplished with the read/write frames via the standard IT services using UDP/IP. Allgemeine

11.2.1 Function

The read/write commands can be triggered if there is a connection between the controller and the IO device, i.e. a "Connect" has taken place.

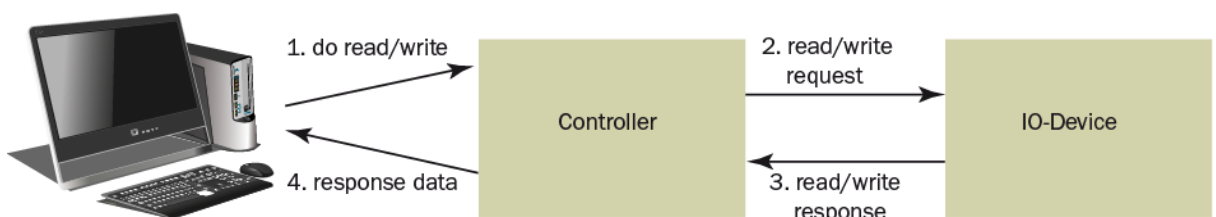

Figure33: Read- / Write-cycle

A computer with the corresponding application can now request a "read" or "write" to a data model of the controller. This executes the read/write command via PROFINET and returns the status or the data to the computer.

11.2.2 Services und Protocols

The following services and protocols are used:

- RTC Real Time Cyclic Protocol
- RT_CLASS_1 (unsynchronisiert)
- R TA Real Time Acyclic Protocol
- DCP Discovery and Configuration Protocol
- DCE /RPC Distributed Computing Environment /Remote Procedure Calls, Connectionless RPC
- LLDP Link Layer Discovery Protocol
- PTCP Precision Transparent Clock Protocol
- SNMP Simple Network Management Protocol

All other services required for PROFINET are also permitted.

The electronics can be loaded with the above services at any time.

In addition, other services can be used as long as they do not exceed the network load according to Netload Class III for Normal Operation.

11.3 Cyclic data traffic

After a successful system start, the IO controller and the assigned IO devices can exchange cyclic process data. The following table shows which measurement data are transmitted in which form.

Cyclic data traffic reads the operating status of the evaluation electronics in a defined time cycle and updates it in the PLC. The PLC defines the cycle time for its protocol. The operating status is used to monitor the operation of the evaluation electronics.

The following table shows which data is available and how it must be interpreted.

Sub-slot	Type	Parameter	Unit	Valid range and number format	Description
2	INT32	Last Error		0	No Error
				1	A taring is not allowed while a batch runs.
				2	The taring cannot be started while a batch runs.
				3	The taring cannot be stopped when not a taring is running.
				4	A reset of the batch be cannot be executed while a batch runs.
				5	Taring cannot be started when the belt stands still.
				6	Not permitted when the device is sealed (750 only).
3	UINT32	Status			

Sub-slot	Type	Parameter	Unit	Valid range and number format	Description
		Bit 0 State of Digital Input 1 Taring belt scale		True False	Taring belt scale (edge triggered ↑) No action
		Bit 1: State of Digital Input 2 Start batch		True False	Start batch (edge triggered ↑) No action
		Bit 2: State of Digital Input 3		True False	Conveyor belt runs (BMGZ710.PNET) Sealed (BMGZ750.PNET) Conveyor belt stands still (BMGZ710.PNET) Unsealed (BMGZ750.PNET)
		Bit 3: State of Digital Output 1 BMGZ OK		True False	BMGZ runs ok The BMGZ has encountered a hardware problem. Consult the status bits 7 to 10 for more information.
		Bit 4: State of Digital Output 2 Taring Active		True False	Taring is active Taring is inactive
		Bit 5: State of Digital Output 3 Remote Counter Pulse		True False	Remote Counter counts up one digit (edge triggered ↑) No action
		Bit 6: State of Digital Output 4 Remote Counter Reset		True False	Remote Counter is reset (edge triggered ↑) No action
		Bit 7: Load cell overload		True	The load cell is loaded with too much weight and reached the mechanical stop.
		Bit 8: Analog output overflow		True	The analog output is in overflow. This happens when the parameter Scaling is set too high.
		Bit 9: Analog output underflow		True	The analog output is in the underflow state. This happens when the system is not correctly calibrated.
		Bit 10: Pulse output too fast		True	The pulse output frequency is too fast.
				Bit 12 to 31:	
4		Total	t	0 to 2 ³¹ -1 #	Overall total
5	INT32	Batch	t	0 to 4'000'000' 000 #.###	Batch

Sub-slot	Type	Parameter	Unit	Valid range and number format	Description
6	INT32	Batch Number		0 to 2 ³¹ -1 #	Batch number
7	INT32	Q	t/h	0 to 5'000'000 #.###	Delivery rate
8	INT32	v	m/s	0 to 10'000'00 ###	Conveyor belt speed
9	INT32	Raw ADC value	Digit s	-32'768 to 32'767	Read ADC input value without signal processing.
10	INT32	Load cell raw voltage	mV	-20'000 to 20'000 #.###	Read load cell input voltage without any signal processing.
11	INT32	Load cell force voltage	mV	-20'000 to 20'000 #.###	Offset corrected load cell input voltage.
12	INT32	Force	N	- 999'999'99 9 to 999'999'99 9 #.###	
13	INT32	Belt	kg/ m	0 to 999'999'99 9 #.###	
14	INT32	Taring countdown time	s	0 to 600	Remaining time until the taring is over.
15	INT32	Temperature	°C	-9'999 to 9'999 #.##	The temperature at the weighing device (BMGZ750.PNET only).

Table 3: cyclic data traffic PROFINET

11.4 Acyclic data traffic

After successful system startup, IO controllers and the assigned IO devices can exchange acyclic demand data. The table below shows which parameters and commands are transmitted in which form with the acyclic data traffic.

For addressing the parameters 0x01 to 0x08 the slot 1, module Feedback, "Parameter Access Point" is to be used.

The screenshot shows the HW Config interface for a SIMATIC 300 station. The rack configuration table is as follows:

Slot	Module
1	CPU 315-2PN/DP
X1	MP/DI
X2	PN-IO
X2.P1	Port 1
X2.P2	Port 2
3	
4	
5	
6	
7	

The hardware catalog on the right shows the following structure:

- PROFIBUS-DP
- PROFIBUS-PA
- PROFINET IO
 - Gateway
 - HMI
 - I/O
 - Network Components
 - Schaltgeräte
 - Sensors
 - Weitere FELDERGERÄTE
 - Controllere
 - Belt Scales
 - Belt Scale BMGZ710 Rev. 1.0
 - Calibratable Belt Scale BMGZ750 Rev. 1.0
 - Web Guides
 - Drives
 - Gateway
 - I/O
 - Sensors

- SIMATIC 300
- SIMATIC 400
- SIMATIC PC Based Control 300/400
- SIMATIC PC Station

The parameter table for the BMGZ710 module is as follows:

Parameter	Steckplatz	Baugruppe	Bestellnummer	E-Adresse	A-Adresse	Diagnoseadresse	Kommentar
0	1	PROFINET-IO	BMGZ710			2039*	
X1						2042*	
P1.R		Port 1				2041*	
P2.R		Port 2				2040*	
0.1		Identification/Maintena...				2038*	
0.10		Parameter Access Point				2036*	
1	1	Feedback				2037*	
1.1		Parameter Access Point				2037*	
1.2		Last Error		256...259			
1.3		Status		0...3			
1.4		Total (t)		260...263			
1.5		Batch (t)		264...267			
1.6		Batch Number		268...271			
1.7		G (t/h)		272...275			
1.8		v (m/s)		276...279			
1.9		Raw ADC value		280...283			
1.10		Load cell raw voltage (*		284...287			
1.11		Load cell force voltage (*		288...291			
1.12		Force (N)		292...295			
1.13		Belt (kg/m)		296...299			
1.14		Taring countdown time (*		300...303			

Figure34: BMGZ710.PNET configuration PLC

A PLC can exchange acyclic data with the evaluation electronics. This data is used for configuration and remote control of the evaluation electronics.

The following table shows all commands for parameter configuration. The parameters can be read and written.

Sub-slot	Type	Parameter	Unit	Valid range and number format	Description
Machine parameters					
1	UINT16	Offset		-32'768 to 32'767 #	
2	UINT16	Gain		100 to 20'000 #.###	
3	UINT16	Belt length	m	1 to 5'000 #	
4	UINT16	Diameter	mm	10 to 1'000 #	
5	UINT16	Pulses		1 to 100 #	
6	UINT16	Distance	mm	100 to 5'000 #	
7	UINT32	Nominal force	N	1 to 200'000 #	
8	UINT16	Max. Q	t/h	0 to 5'000 #	
9	UINT16	v-acquisition (BMGZ710.PNET) Direction BMGZ750.PNET		0 1	None (BMGZ710.PNET) Inverse (BMGZ750.PNET) Auto (BMGZ710.PNET) Standard (BMGZ750.PNET)
Operating parameters					
10	UINT16	Pulse output	kg	1 to 1'000 #	
11	UINT16	Current output mode		0 1	0 to 20mA 4 to 20mA
12	UINT16	Filter output	Hz	1 2'000 #. #	
13	UNIT16	Scaling	t/h	10 to 50'000 #. #	Manual Automatic

Sub-slot	Type	Parameter	Unit	Valid range and number format	Description
System parameters					
14	UINT16	Language		0 1	German English
15	UINT16	Filter display	Hz	1 to 100 #. #	
16	UINT16	Date format		0 1	DD.MM.YYYY MM/DD/YYYY
17	INT32	Device Time of day	ms	0 to 86'399'999 #	Current device time. The value represents the number of ms since midnight.
18	UINT16	Device Date		4018 to 42404 #	Current device date. The value represents the number of days since 1990-1-1 (4018 = 2001-1-1 / 42404 = 2106-02-06)
19	UINT16	Recording Time	Min	1 to 600 #	Histogram recording duration of the x-axis.
20	UINT16	Histogram Scaling	t/h	0 to 5'000 #	Histogram scaling of the y-axis.
Alibi protocol					
21	INT32	Request batch log by number		0 to $2^{31}-1$ #	Request batch log by the batch number. If the number is zero, then the latest batch is read.
22	INT32	Log Index		0 to $2^{31}-1$ #	Log Index indicates the index of the actual read data record. This can be different from the requested index when the requested doesn't exist. If the index is negative, then the data record is corrupt.
23	INT32	Logged Batch number		0 to $2^{31}-1$ #	
24	INT32	Logged Batch	t	0 to 4'000'000'000 #.###	
25	UINT16	Logged start date	Date	4018 to 42404 #	Start date of the logged batch. The value represents the number of days since 1990-1-1 (4018 = 2001-1-1 / 42404 = 2106-02-06)
26	UINT32	Logged start time	ms	0 to 86'399'999 #	Start time of the logged batch. The value represents the number of ms since midnight.

Sub-slot	Type	Parameter	Unit	Valid range and number format	Description
27	UINT16	Logged end date	Date	4018 to 42404 #	End date of the logged batch. The value represents the number of days since 1990-1-1 (4018 = 2001-1-1 / 42404 = 2106-02-06)
28	UINT32	Logged end time	ms	0 to 86'399'999 #	End time of of the logged batch. The value represents the number of ms since midnight.
29	INT32	Total	t	0 to $2^{31}-1$ #	Overall total at the end time
30	UINT16	Logged Mode		0 to 255	0: Ok 1: Q < 20% or Q > 100% >= 2: Data record corrupt.

Table 4: acyclic process data PROFINET, parameter configuration

The following table shows the commands for remote control. For the remote control commands, only writing is useful.

Note, however, that it is possible to write the same value again. This will also execute the command again.

Sub-slot	Type	Parameter	Unit	Valid range and number format	Description
50	UINT16	Start Batch		0 1	Do nothing Starts the batch
51	UINT16	Stop Batch		0 1	Do nothing Stops the batch
52	UINT16	Reset Batch		0 1	Do nothing Resets the batch weight
53	UINT16	Start belt scale taring		0 1	Do nothing It starts a taring of the belt scale until the taring status gets inactive or it is stopped.
54	UINT16	Stop belt scale taring		0 1	Do nothing It stops a running taring of the belt scale.
55	INT32	Calibrate belt scale	t	0 to 4'000'000' 000 #.###	Calibrate the belt scale with the reference weight and the last batch weight.
56	UNIT16	Reset Last Error		0 1	Do nothing Reset register last error in the operating status area. That ensures that an occurrence of an error is new.

Table 5: acyclic data PROFINET, remote control

12 Technical data BMGZ710

BMGZ710 : Technical data	
Accuracy class electronics	0.05 %
Number of channels	1, for one measuring roller
Displayed values	total amount [t], daily amount or batch [t], actual performance [t/h], belt speed [m/s] as absolute value or histogram
Daily amount, batch counter	0 to 1,000 t (resolution 5 kg); 1,000 to 10,000 t (resolution 10 kg); 10,000 to 100,000 t (resolution 100 kg); 100,000 to 1,000,000 t (resolution 1000 kg)
Operation and display	4 buttons, graphical, illuminated 128 x 64 px STN LCD, alternatively via web browser
Total amount	0 to 1 Mio. t (resolution 1000 kg)
Digital outputs	Tare active, 24 VDC, max. 100 mA; Belt scale o.k., 24 VDC, max. 100 mA; Remote counter, impulse 1 to 1000 ms, 24 VDC, max. 100 mA; Reset remote counter, 24 VDC, max. 100 mA
Digital inputs	start tare procedure, production batch active, speed probe, 24 VDC
Analogue output	Current output: 0/4 to 20 mA, min. 500 Ω or power output: 1 to 10 VDC, min. 1000 Ω
Cycle time	1 ms
Temperature range	-10 to +50 °C (14 to 122 F)
Power supply	24 (18 to 36) VDC
Power consumption	5 W
Analogue outputs	Actual performance, 0 to 10 VDC or 0/4 to 20 mA
Weight	1.5 kg (2.2 lbs.)

Table 7: Technical data BMGZ710

12.1 Specification PROFINET interface

BMGZ710.PNET : PROFINET Features	
Cycle time	0.5 ms for RT_CLASS_3, 1 ms for RT_CLASS_1
Media redundancy	Media Redundancy Protocol (MRP) – Client
IRT Support	Yes, RT_CLASS_3, synchronous with network clock
Integrated Switch	2 Port
PROFINET IO specification	V 2.3, legacy startup of specification V 2.2 is supported
Certification	PNIO version V 2.35, net load class: CLASS III, conformance class (CC-C)

Table 8: specifications PROFINET





FMS Force Measuring Systems AG
Aspstrasse 6
8154 Oberglatt (Switzerland)
Tel. +41 44 852 80 80
info@fms-technology.com
www.fms-technology.com

FMS USA, Inc.
2155 Stonington Avenue Suite 119
Hoffman Estates, IL 60169 (USA)
Tel. +1 847 519 4400
fmsusa@fms-technology.com