

# Series ZD / ZA / ZR 330 – 644

## High Speed Position Counters and Differential Counters with two Encoder Inputs



- Electronic counter series for high-end applications
- Two independent encoder inputs, each with channels A, /A, B, /B , 1 MHz of counting capability and individual impulse scaling facility
- Selectable operating modes for fast position or event counter, summing counter, differential counter, cutting length indicator, diameter calculator and more
- 4 preset levels with high-speed power transistor outputs
- RS232 interface and high-speed analogue output available, RS485 (only ZR)
- Choice of 6-decade display (15 mm, 0.56") or 8-decade display (10 mm, 0.36")

## Operating Instructions



## Safety Instructions

- This manual is an essential part of the unit and contains important hints about function, correct handling and commissioning. Non-observance can result in damage to the unit or the machine or even in injury to persons using the equipment!
- The unit must only be installed, connected and activated by a qualified electrician
- It is a must to observe all general and also all country-specific and application-specific safety standards
- When this unit is used with applications where failure or maloperation could cause damage to a machine or hazard to the operating staff, it is indispensable to meet effective precautions in order to avoid such consequences
- Regarding installation, wiring, environmental conditions, screening of cables and earthing, you must follow the general standards of industrial automation industry
- - Errors and omissions excepted –



General instructions for cabling, screening and grounding can be found in the SUPPORT section of our website <http://www.motrona.com>

Version:	Description:
ZD34001b/Mai06/hk/kk/af	First edition
ZD34002a/Jul06/af/hk	Extended modes of operation
ZD34003a/Aug06/hk	Models ZA_xxx and models xx_330 included
ZD34003c/May06/af/hk	Analogue output assignment, Preset calculation, Serial appendix
ZD34003d/Feb08/hk	Motrona version with small corrections and modifications
ZD34005a/Sept08/hk	Dual counter mode (mode 10), small corrections
ZD34005b/Dec08/hk	Several amendments, additional clarifications
ZD34007a/Dec10/kk/hk	Parameter "Display Update Time", correction of default values, amendments, serial codes added to parameter lists
ZD34007b/Jan12/sm	Additions for using Namur sensors and type definitions
ZD34007c/June12/pp	Corrected images in chapter 1 and 7.2
ZD34007d/April17/cn	Control Commands update

# Table of Contents

1.	Available Models .....	4
2.	Introduction.....	6
3.	Electrical Connections.....	7
3.1.	Power Supply .....	9
3.2.	Auxiliary Outputs for Encoder Supply.....	9
3.3.	Impulse Inputs for Incremental Encoders .....	9
3.4.	Control Inputs Cont.1 – Cont.4 .....	9
3.5.	Switching Outputs K1 – K4.....	10
3.6.	Serial Interface .....	10
3.7.	Fast Analogue Output .....	10
4.	Operating Modes of the Counter.....	11
4.1.	“Single Mode” (Encoder 1 only): <u>F07.062 = 0</u> .....	12
4.2.	“Sum Mode” (Encoder 1 + Encoder 2): <u>F07.062 = 1</u> .....	13
4.3.	Differential Mode (Encoder 1 – Encoder 2): <u>F07.062 = 2</u> .....	14
4.4.	Master Counter and Integrated Batch Counter: <u>F07.062 = 3</u> .....	15
4.5.	Evaluation of the Real Cutting Length: <u>F07.062 = 4</u> .....	16
4.6.	Diameter Calculation with Winding Rolls: <u>F07.062 = 5</u> .....	17
4.7.	Radius Calculation with Winding Rolls: <u>F07.062 = 6</u> .....	18
4.8.	Cut-to-Length Control Counter: <u>F07.062 = 7 or 8</u> .....	19
4.9.	Monitor for Slip, Torsion, Skew Position, Shaft Fracture: <u>F07.062 = 9</u> .....	21
4.10.	Dual Counter, Two Independent Counters for Encoders 1 and 2: <u>F07.062 = 10</u> .....	22
5.	Keypad Operation .....	23
5.1.	Normal Operation .....	23
5.2.	General Setup Procedure.....	23
5.3.	Direct Fast Access to Presets .....	24
5.4.	Change of Parameter Values on the Numeric Level .....	25
5.5.	Code Protection against Unauthorized Keypad Access .....	26
5.6.	Return from the Programming Levels and Time-Out Function .....	26
5.7.	Reset all Parameters to Factory Default Values .....	26
6.	Menu Structure and Description of Parameters .....	27
6.1.	Summary of the Menu .....	27
6.2.	Description of the Parameters.....	30
6.3.	Clarification of the Counter Setting Functions .....	39
7.	Appendix for models ZD 6xx and ZA 6xx .....	40
7.1.	Relay Outputs.....	40
7.2.	Front Thumbwheel Switches .....	40
7.3.	Specific Parameters for Units with Thumbwheel Switches .....	41
8.	Appendix: Serial Communication Details .....	43
8.1.	Setup of the Counter by PC.....	43
8.2.	Automatic and Cyclic Data Transmission.....	44
8.3.	Communication Protocol.....	44
8.4.	Serial Register Codes .....	46
9.	Specifications .....	48
10.	Dimensions .....	49

# 1. Available Models

The ZD, ZA and ZR counter series include a range of models with similar functions and properties, but with different housings, displays and outputs.

ZA counters provide an additional high-speed analogue output which is not available with the ZD or ZR models. However the ZR models have an additional RS485 interface, but otherwise all details between ZD, ZA and ZR models are fully similar.

The following table explains the details of type designation and the possible options:

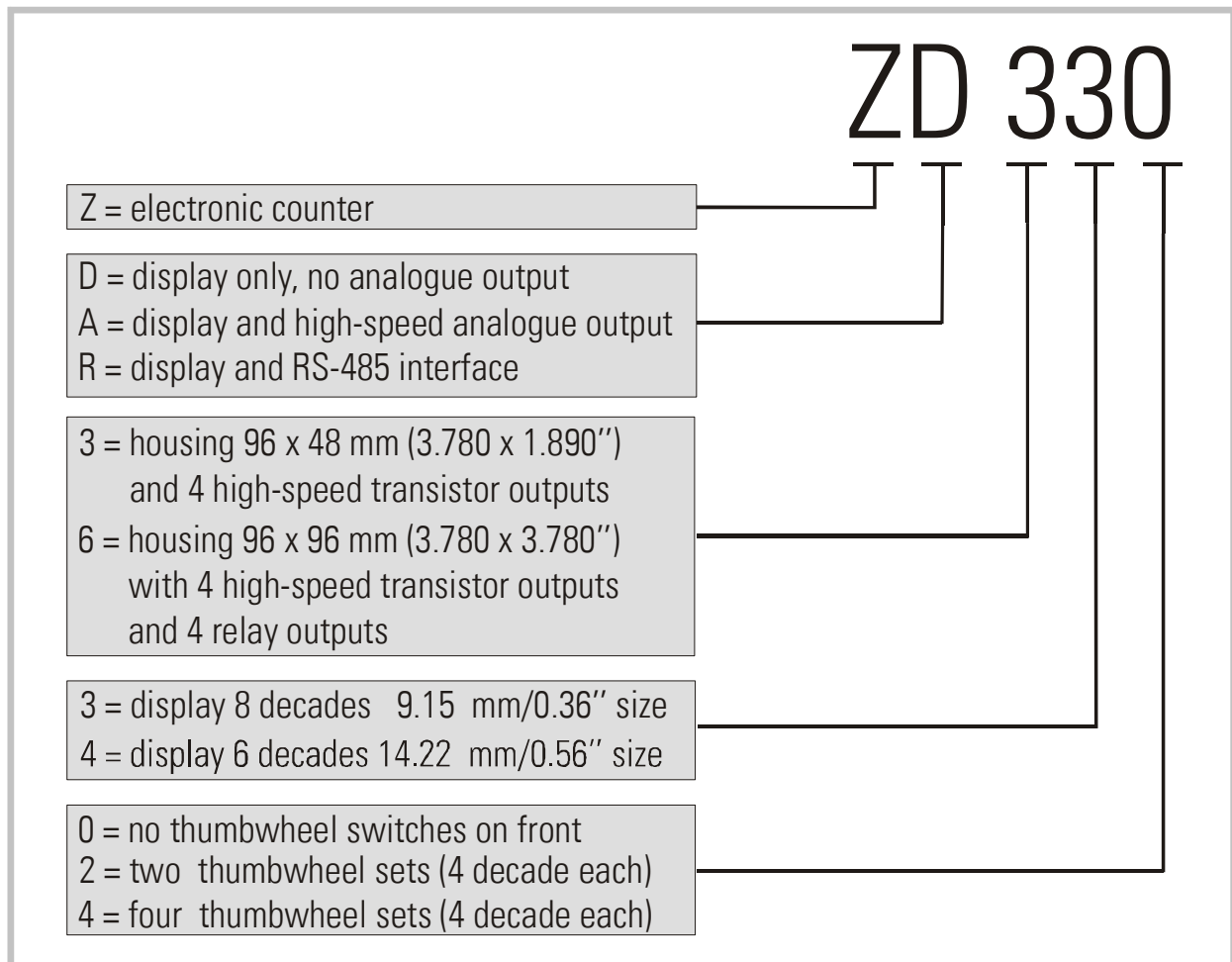

The following models are available:

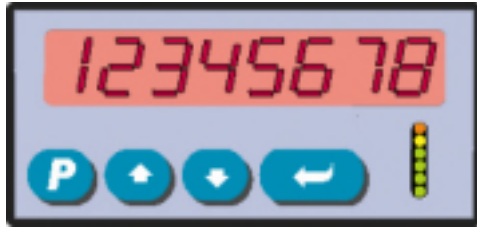

ZD 330, ZA 330, ZR 330



ZD 340, ZA 340, ZR 340

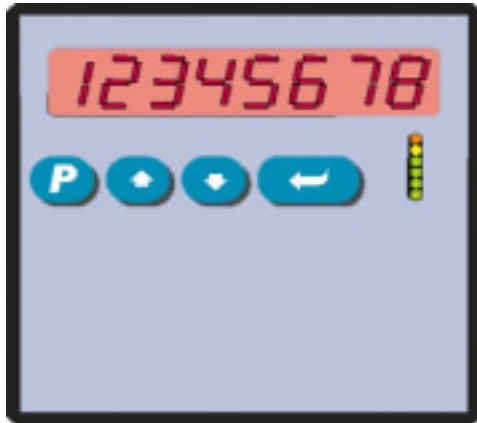

ZD 630, ZA 630, ZR 630



ZD 640, ZA 640, ZR 640



ZD 632, ZA 632, ZR 632



ZD 642, ZA 642, ZR 642



ZD 634, ZA 634, ZR 634

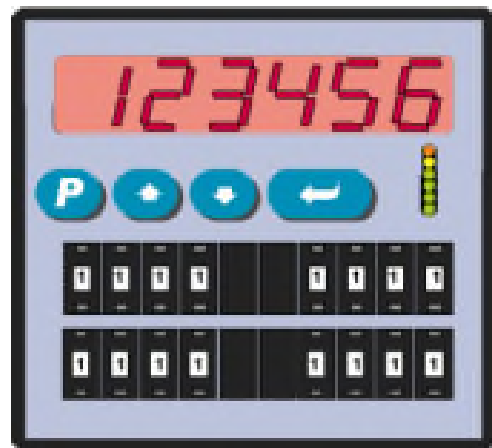

ZD 644, ZA 644, ZR 644

Number and combination of front thumbwheels according to customer specification, see section 7.2

## 2. Introduction

The counters of series ZD, ZA and ZR have been designed to close a gap with multiple counting applications, which cannot be accomplished by the normal industrial electronic counters available on the market.

A continual demand for increasing production speeds and higher precision at the same time results in counting frequencies exceeding the conventional frequency range.

Particularly with fast running procedures it is most important to also have fast response of the switching outputs or the analogue output.

Many applications require to evaluate the signals of two incremental measuring systems, and to compare the results with respect to the sum or the difference or the ratio of the two positions. This is e.g. necessary for calculation of diameters of winding rolls etc.

Still there exist applications where the use of traditional thumbwheel switches offers real advantages compared to keypad and menu operations.

These are some of the reasons why the new counter series ZD, ZA and ZR have been designed.



- This manual at first provides all basic instructions for operation of the counter models presented in the previous chapter
- For operation of relay outputs and thumbwheel switches (if applicable) please observe the supplementary instructions given in the appendix
- For easy PC setup and PC communication with ZD and ZA counters, please use our "OS32" operator software (free of charge, download from our homepage [www.motrona.com](http://www.motrona.com))
- Where you like to have free serial access to the unit by PLC or IPC or by a remote operator terminal, please observe the serial protocol details described in our separate manual "Serpro"
- Subsequently the manual uses the expression ZD340 as a replacement for all available models. However, statements are fully valid for the other models too, except where especially remarked.

### 3. Electrical Connections

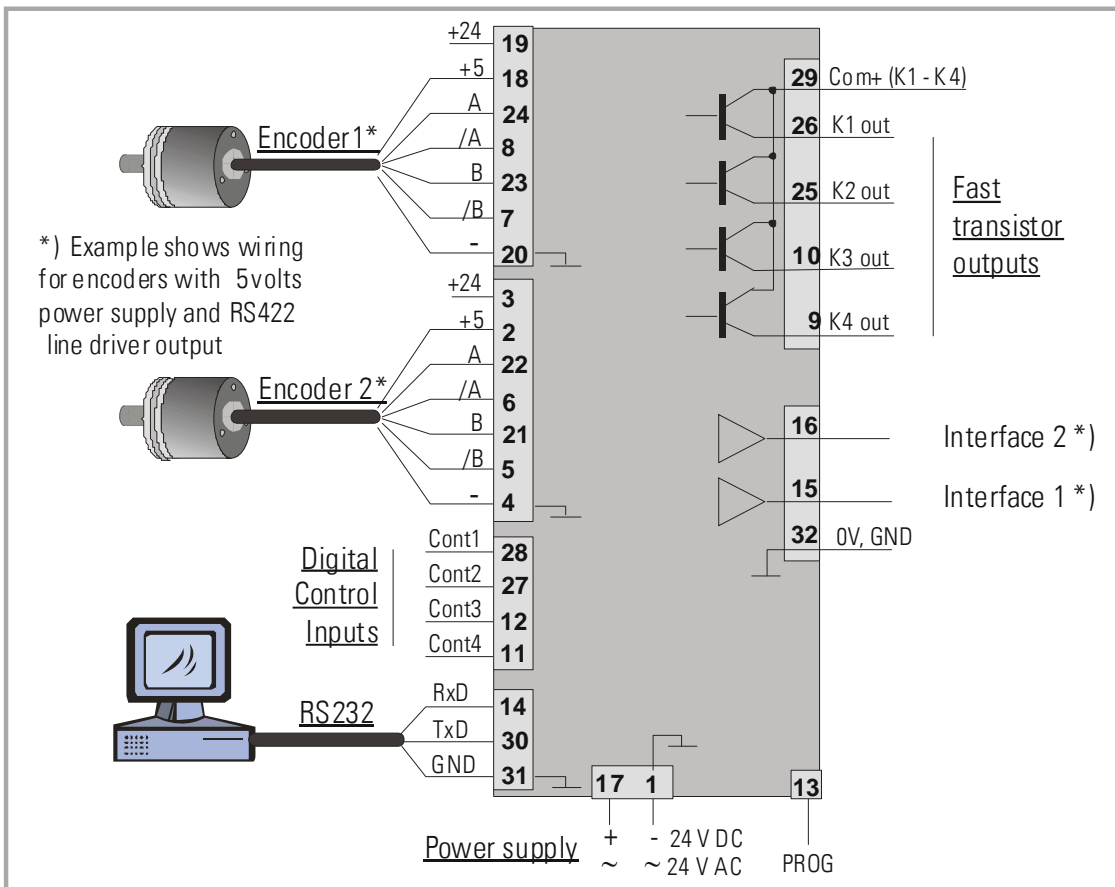
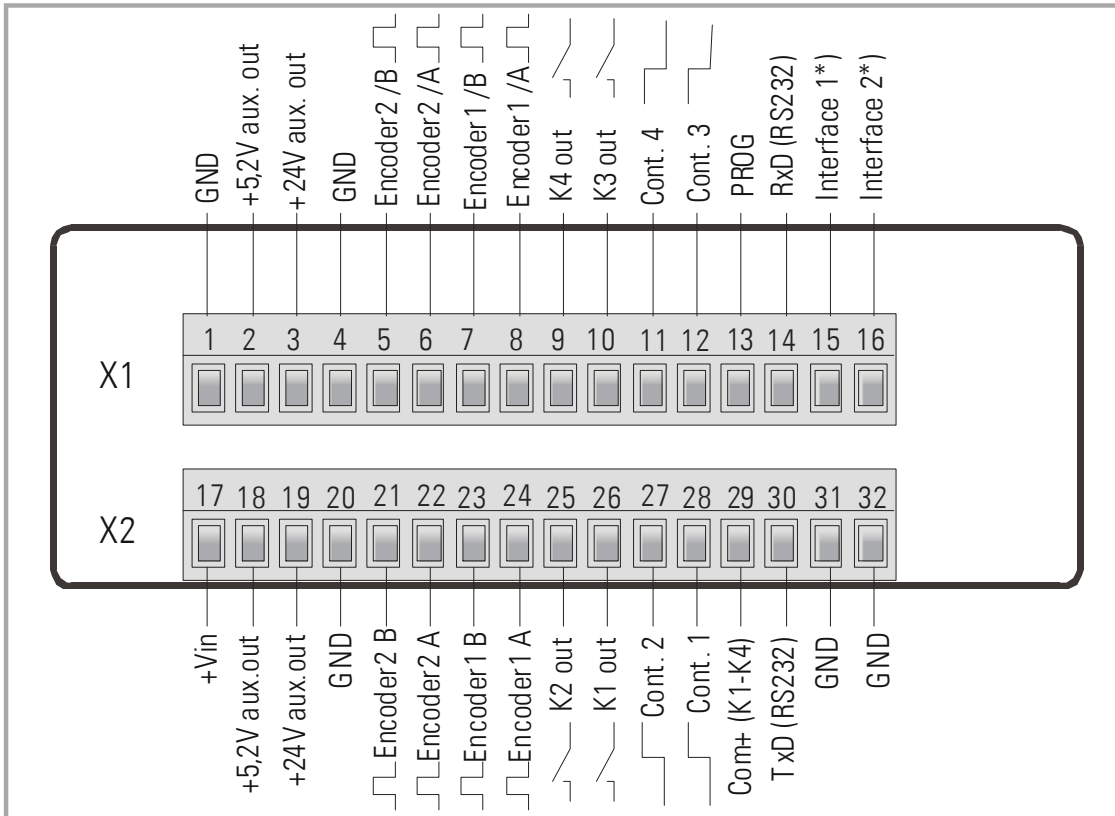

	Series "ZD"	Series "ZA"	Series "ZR"
*) Interface 1:	- n.c. -	Analogue output 0/4 - 20 mA	RS 485, B (-)
*) Interface 2:	- n.c. -	Analogue output +/- 10 V	RS 485, A (+)

Terminal	Name	Function
01	GND	Common Ground Potential (0V)
02	+5,2V out	Aux. output 5.2V/150 mA for encoder supply
03	+24V out	Aux. output 24V/120 mA for encoder supply
04	GND	Common Ground Potential (0V)
05	Encoder 2, /B	Encoder 2, channel /B (B inverted)
06	Encoder 2, /A	Encoder 2, channel /A (A inverted)
07	Encoder 1, /B	Encoder 1, channel /B (B inverted)
08	Encoder 1, /A	Encoder 1, channel /A (A inverted)
09	K4 out	Output K4, transistor PNP 30 volts, 350 mA
10	K3 out	Output K3, transistor PNP 30 volts, 350 mA
11	Cont.4	Digital control input
12	Cont.3	Digital control input
13	(PROG)	(for download of new firmware only, not for general use)
14	RxD	Serial RS232 interface, input (Receive Data)
15	Ana.out 20 mA	Analogue current output 0 – 20 mA or 4 – 20 mA (optional)
16	Ana.out +/-10V	Analogue voltage output -10V ... 0 ... +10V (optional)
17	+Vin	Power supply input, +17 – 40 VDC or 24 VAC
18	+5,2V out	Aux. output 5,2V/150 mA for encoder supply
19	+24V out	Aux. output 24V/120 mA for encoder supply
20	GND	Common Ground Potential (0V)
21	Encoder 2, B	Encoder 2, channel B (non-inverted)
22	Encoder 2, A	Encoder 2, channel A (non-inverted)
23	Encoder 1, B	Encoder 1, channel B (non-inverted)
24	Encoder 1, A	Encoder 1, channel A (non-inverted)
25	K2 out	Output K2, transistor PNP 30 volts, 350 mA
26	K1 out	Output K1, transistor PNP 30 volts, 350 mA
27	Cont.2	Digital control input
28	Cont.1	Digital control input
29	Com+ (K1-K4)	Common positive input for transistor outputs K1-K4
30	TxD	Serial RS232 interface, output (Transmit Data)
31	GND	Common Ground Potential (0V)
32	GND	Common Ground Potential (0V) for DC or AC power supply

\*) 120 mA and 150 mA are per encoder, i.e. total maximum currents are 240 mA and 300 mA



### 3.1. Power Supply

The ZD340 counter accepts both, a 17 – 40 volts DC power or a 24 volts AC power for supply via terminals 17 and 1. The current consumption depends on the level of the input voltage and some internal conditions; therefore it can vary in a range from 100 – 200 mA (aux. currents taken from the unit for encoder supply not included).

### 3.2. Auxiliary Outputs for Encoder Supply

Terminals 2 and 18 provide an auxiliary output with approx. +5.2 volts DC (300 mA totally).  
Terminals 3 and 19 provide an auxiliary output with approx. +24 volts DC (240 mA totally)

### 3.3. Impulse Inputs for Incremental Encoders

All input characteristics of the impulse inputs can be set by the parameter menu, for each of the encoders separately. Depending on the application the unit can accept single channel information (input A only) or quadrature information (A / B, 90°). The following settings are possible:

- Symmetric input (differential) according to RS422 standard (min. differential voltage 1 V)
- TTL inputs at a level of 3.0 to 5 volts (differential, with inverted signal)
- TTL inputs at a level of 3.0 to 5 volts (single-ended) \*)
- HTL signals at a 10 – 30 volts level  
(alternatively differential with inverted signals A, /A, B, /B, or single-ended A, B only)
- Impulses from photocells or proximity switches etc. providing a HTL level (10 – 30 volts)
- Proximity switches according to NAMUR (2-wire) standard have an input level of 5,8V respectively 19,4V. For a save crossover point set the threshold setting of the used input to the value 200. \*)



All encoder input lines are internally terminated by pull-down resistors ( 8,5 k $\Omega$  ).  
Where encoders with pure NPN outputs are used, corresponding pull-up resistors must be available inside the encoder or externally to ensure proper function (1 k $\Omega$  ... 3,3 k $\Omega$ ).

### 3.4. Control Inputs Cont.1 – Cont.4

These inputs can be configured for various remote functions like Reset, Set, Latch, and Inhibit or switch-over purpose.

All control inputs require HTL level. They can be individually set to either NPN (switch to -) or PNP (switch to +) characteristics. For applications where edge-triggered action is needed, the menu allows to set the active edge (rising or falling). Control inputs also accept signals with Namur (2-wire) standard. For reliable operation the minimum pulse width on the control inputs should be 50  $\mu$ sec.

\*) requires special settings of the threshold parameters, see "Special parameters F04"

### 3.5. Switching Outputs K1 – K4

ZD340 provides four presets and outputs with programmable switching characteristics. K1 – K4 are fast-switching and short-circuit-proof transistor outputs with a switching capability of 5 – 30 volts / 350 mA each. The switching voltage of the outputs must be applied remotely to the Com+ input (terminal 29)

### 3.6. Serial Interface

The serial RS232 and RS485 interface can be used for the following purposes:

- Set-up of the unit by PC (if desirable), by means of the OS32 PC software
- Change of parameters during operation
- Readout of actual counter or other values by PLC or PC

The figure below explains the connection between the ZD340 counter and a PC using the standard Sub-D-9 serial connector, and the connection via RS485 terminals to a PLC. For details of serial communication, please refer to section 10.

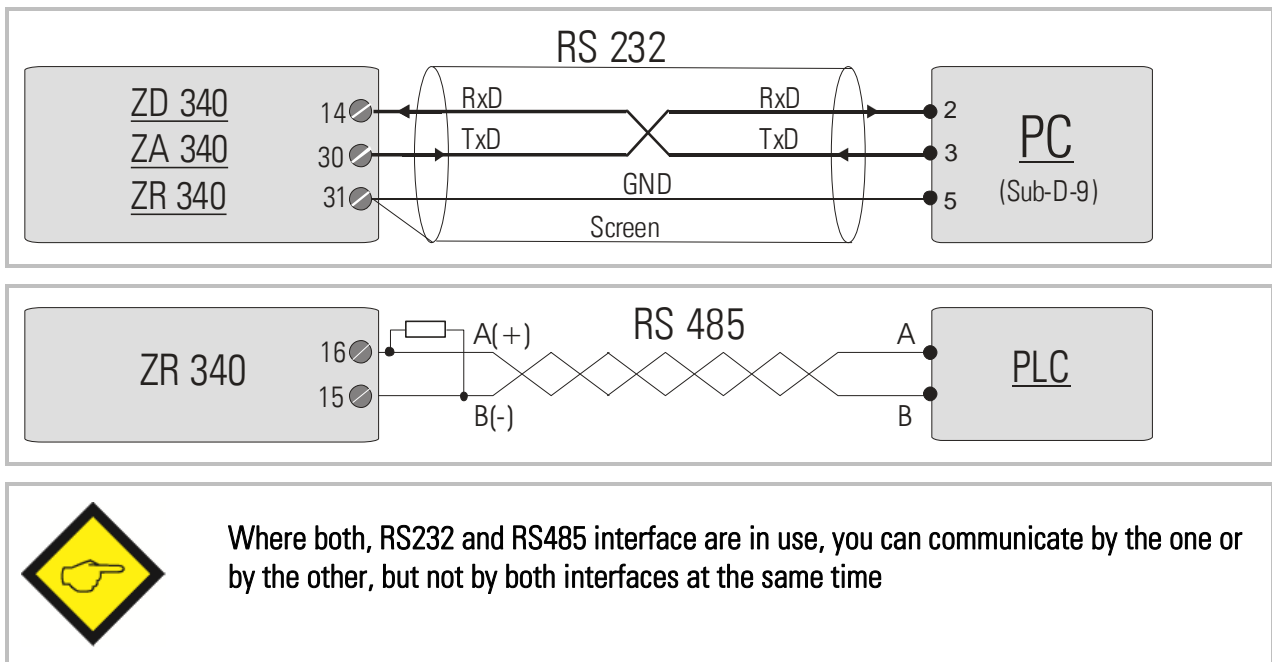

### 3.7. Fast Analogue Output

An analogue output is available with all ZA models, providing a voltage output of +/- 10 volts (Load = 3 mA), and a current output of 0 – 20 mA or 4 – 20 mA (load = 0 – 270 Ohms). All output characteristics like beginning of conversion range, output swing etc. are freely programmable via menu. The response time of the analogue output is less than 1 msec. (time from encoder event to analogue out). The resolution is 14 bits.

Please note that extensive serial communication with the unit may temporary increase the analogue response time.

## 4. Operating Modes of the Counter

For best survey, all parameters of the unit are arranged in 13 expedient groups, named "F01" - "F13". Depending on the application, only a few of these groups may be important, while all other groups may be irrelevant for your specific application.

This section describes possible applications and operating modes of the counter. The operation mode can be set under parameter group F07, parameter # F07.062.

The following counting functions are available:

Operating Mode F07.062	Counter Function
0	Single counter mode, encoder 1 only
1	Summing counter mode (encoder 1 + encoder 2)
2	Differential counter mode (encoder 1 - encoder 2)
3	Master counter and batch counter
4	Display of the actual cutting length with cutting "on the fly" applications
5	Roll diameter calculation with winding rolls
6	Roll radius calculation with winding rolls
7	Cut-to-length control (with deletion of residual errors)
8	Cut-to-length control (with consideration of residual errors)
9	Control of slip, torsion, skew position, shaft fracture etc.
10	Dual counter, two independent counters for encoder 1 and encoder 2



- It is possible to cycle the display between the five reading modes shown in the following function tables, by pressing one of the front keys or by using one of the control inputs (you must have assigned the display scroll function to one of the keys or the inputs under menu F06, to activate the scrolling of the display). LEDs L1 and L2 indicate which of the values is actually displayed.
- Scrolling of the display from one reading mode to another will not affect the function of the preselection outputs K1 – K4
- The analogue output (models ZA) can be assigned to any of the readings accessible in the display, by a special parameter. Scrolling of the display from one reading mode to another will not affect the analogue output.
- As far as the selected counter mode also allows reading out the minimum and maximum values or the positions of the last change of direction, please note that the unit latches these extreme values in time periods of 1 msec. only. Therefore the display of memorized extreme positions may include some inaccuracy with high counting frequencies (real extreme value may lie between two records)

Full details about parameter arrangement and function can be found under section 6.



All operating modes provide separate impulse scaling factors for each of the two encoders. Please observe that the display of the counter will only show whole numbers (integers) whereas remainders will be carried in the background

Example: Differential Counter:

Encoder1		Impulse Scaling Factor1		Encoder2		Impulse Scaling Factor2		Display	Remainder (background)
1000 Impulses	x	0,98765	minus	2000 Impulses	x	1,23456			
		967,65000	-			2469,12000	=	-1501	0,47000

#### 4.1. "Single Mode" (Encoder 1 only): F07.062 = 0

Only the inputs of encoder 1 are active, signals on the encoder 2 inputs will not be evaluated. Besides the actual counter value, the unit also records minimum and maximum values as well as the last positions of change of direction.

All 4 presets are related to the actual counter value.

	Display	L1 (red)	L2 (yellow)
1	Actual counter value	--	--
2	Minimum value since last reset	blinking fast	--
3	Maximum value since last reset	--	blinking fast
4	Position of last change of direction (up and low)	blinking slow	--
5	Only lower point of change of direction (F04.030 = 0) Only upper point of change of direction (F04.030 = 1)	--	blinking slow

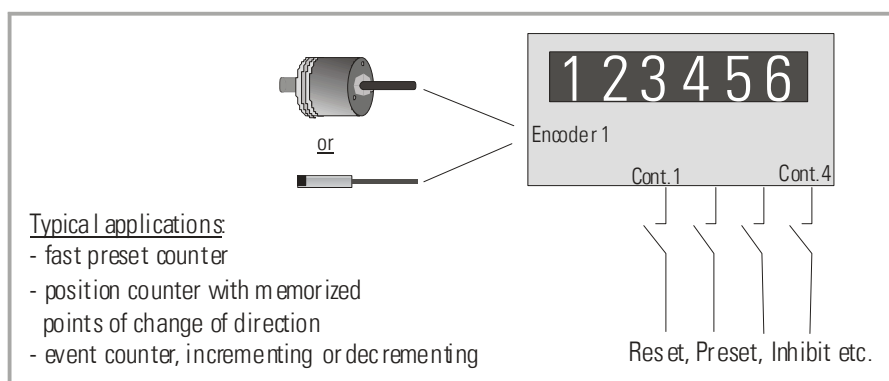

## 4.2. "Sum Mode" (Encoder 1 + Encoder 2): F07.062 = 1

Both inputs encoder 1 and encoder 2 are active. From both values the unit forms the sum, with consideration of the individual encoder scaling factors. Where the encoder signal also provides direction information, this information will be considered by a corresponding sign of the count. Without direction information (channel A only) both encoder values will be added up. The final result can once more be scaled into user-friendly engineering units by means of the special scaling parameters in parameter group F07.

Besides the actual counter value and the sum, the unit also records minimum and maximum values of the sum.

Presets K1 and K2 are related to the actual counter value of encoder 1 only.

Presets K3 and K4 are related to the actual sum result (encoder 1 + encoder 2)

	Display	L1 (red)	L2 (yellow)
1	Actual sum encoder 1 + encoder 2	--	--
2	Minimum value of the sum (since last reset)	blinking fast	--
3	Maximum value of the sum (since last reset)	--	blinking fast
4	Actual counter value of encoder 1 alone	blinking slow	--
5	Actual counter value of encoder 2 alone	--	blinking slow

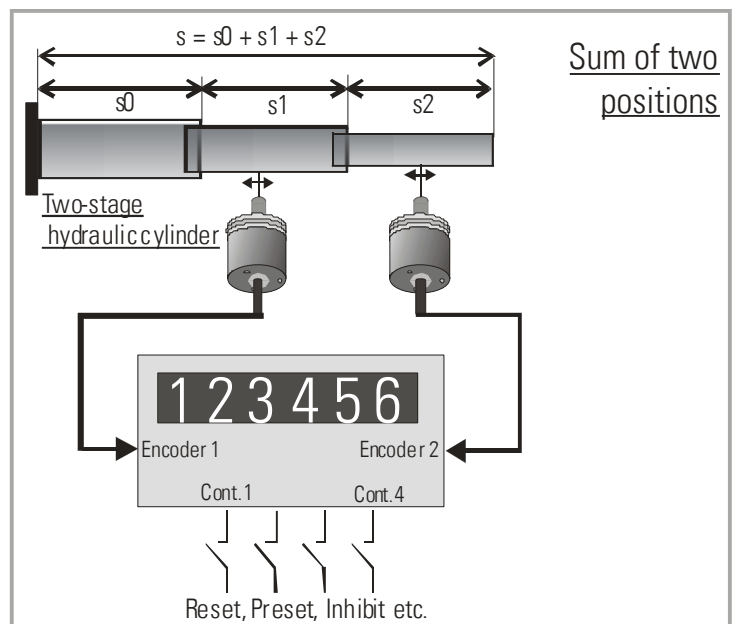
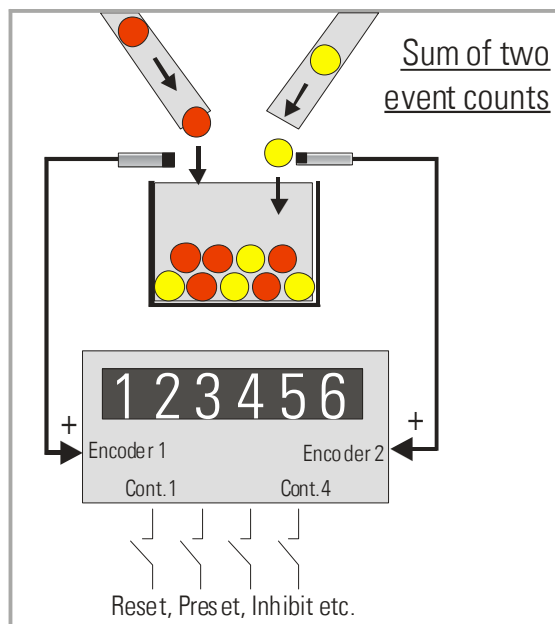

### 4.3. Differential Mode (Encoder 1 – Encoder 2): F07.062 = 2

Both inputs encoder 1 and encoder 2 are active. From both values the unit forms the difference, with consideration of the individual encoder scaling factors.

Where the encoder signal also provides direction information, this information will be considered by a corresponding sign of the count. Without direction information (channel A only) encoder 1 will increment and encoder 2 will decrement the counter. The final result can once more be scaled into user-friendly engineering units by means of the special scaling parameters in parameter group F07.

Besides the actual counter value and the difference, the unit also records minimum and maximum values of the difference.

Presets K1 and K2 are related to the actual counter value of encoder 1 only.

Presets K3 and K4 are related to the actual differential result (encoder 1 - encoder 2)

	Display	L1 (red)	L2 (yellow)
1	Actual difference encoder 1 - encoder 2	--	--
2	Minimum value of the difference (since last reset)	blinking fast	--
3	Maximum value of the difference (since last reset)	--	blinking fast
4	Actual counter value of encoder 1 alone	blinking slow	--
5	Actual counter value of encoder 2 alone	--	blinking slow

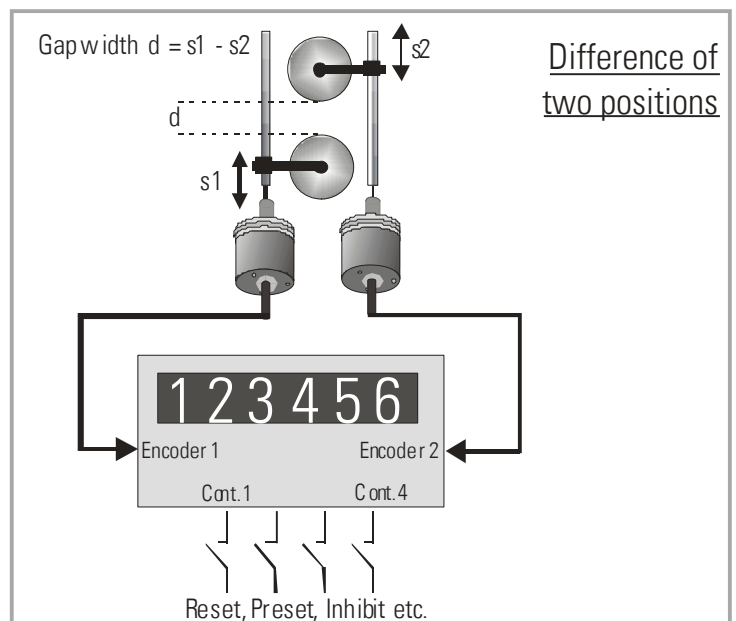
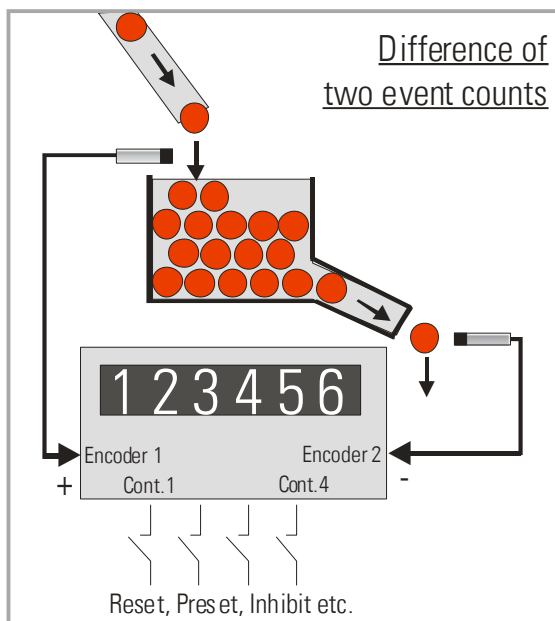

## 4.4. Master Counter and Integrated Batch Counter: F07.062 = 3

This counter mode can be used for cut-to lengths applications, cyclic production flows, packing procedures etc. While the master counter takes care of the correct number of impulses per product, the background batch counter counts the number of products produced.

This mode assumes that the automatic reset function has been activated for the master counter, providing restart from zero every time the preset value has been reached. \*)

Only the inputs of encoder 1 are active (master counter).

Every time the master counter reaches its preset value, it restarts from zero and the batch counter increments by 1. \*\*\*)

The batch counter can be decremented by separate external signal, when one of the keys or control inputs has been defined correspondingly. \*\*)

Besides the master counter and the batch counter, the unit also records minimum and maximum values of the batch count.

Presets K1 and K2 are related to the actual counter value of encoder 1.

Presets K3 and K4 are related to the actual value of the batch counter.

	Display	L1 (red)	L2 (yellow)
1	Actual counter value of batch counter	--	--
2	Minimum value of batch counter (since last reset)	blinking fast	--
3	Maximum value of batch counter (since last reset)	--	blinking fast
4	Actual counter value of master counter (encoder 1)	blinking slow	--
5	Actual counter value of batch counter	--	blinking slow

\*) Example: If 500 impulses on encoder 1 are necessary for 1 product:

- a. Set F01.000 to 500 (preset level 1)
- b. Set F10.089 = 1.00 sec. (output pulse time K1)
- c. Set F10.097 = 2 or 4 (automatic restart from 0)

\*\*) Select parameter group F06 and assign the special command "13" to any of the keys or control inputs for remote decrementing of the batch counter

\*\*\*) As a matter of course the counting sense can also be reversed, i.e. the main counter loads a preset value, counts down towards zero, increments the batch counter when reaching zero and sets to the preset value again

## 4.5. Evaluation of the Real Cutting Length: F07.062 = 4

This mode uses encoder 1 as a length counter and encoder 2 is not active. All counting occurs in the background and is not visible in the display. The counter gets started and stopped by remote control signals, and the final counting result appears in the display (frozen) whilst the counter already executes the next cycle in the background.

For remote start and stop signals the inputs Cont.1 and Cont.2 must be used, therefore these inputs are no more available for other purpose. All assignments of the signals and the active edges (rising or falling) can individually be set to match with the actual measuring situation.

### Examples:

- use the rising edge of the Cont1 input to latch and reset, This will display your cutting length as shown in the picture below.
- Use Cont1 to start the measuring cycle and Cont2 to stop and latch. This will display the differential length between the two remote signals
- Use the same signal in parallel to Cont1 and Cont2. This e.g. allows to measure a gap or distance between two products, while the remote signal is high (or low)

This mode is useful to get information about the actual cutting length with applications like Rotary Cutters, Flying Shears and similar procedures. The automatic reset function is automatically on in order to ensure that the next measuring cycle will restart at zero.

Besides the actual cutting length the unit also records the extreme length values (minimum and maximum) of all cuts.

Presets K1 and K2 are related to the actual counter value of encoder 1 (live background counter). Presets K3 and K4 are related to the real cutting lengths shown in the frozen display. Therefore K3 and K4 can be used for quality sorting purpose (e.g. too short – good – too long)

	Display	L1 (red)	L2 (yellow)
1	Last actual cutting length (frozen)	--	--
2	Minimum length (since last reset)	blinking fast	--
3	Maximum length (since last reset)	--	blinking fast
4	Actual background counter (live)	blinking slow	--
5	Last actual cutting length (frozen)	--	blinking slow

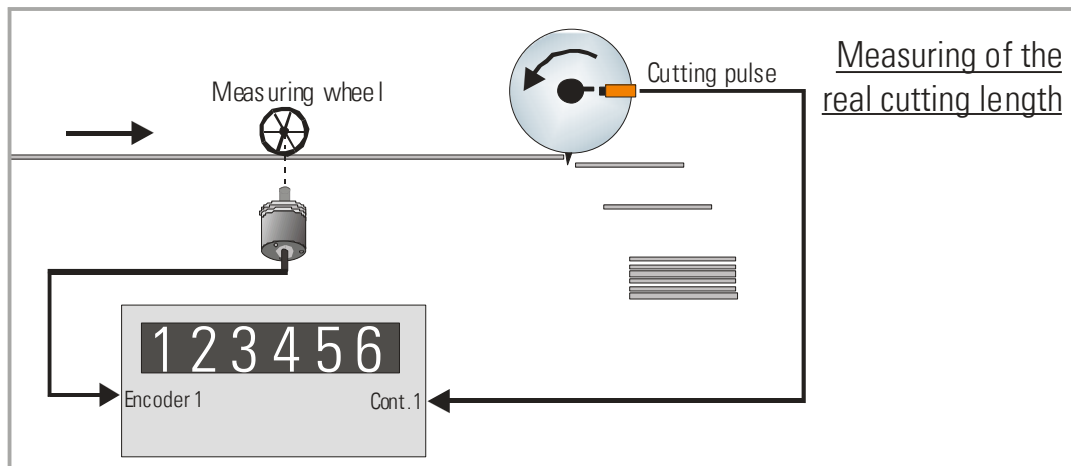



## 4.6. Diameter Calculation with Winding Rolls: F07.062 = 5

With this mode encoder 1 receives line impulses from a measuring wheel or a feed roll of a winder or unwinder application. Furthermore the counter needs one trigger impulse from the rotation of the winding roll. From both signals the counter can calculate and display the actual roll diameter. All counting occurs in the background and only updated diameter readings appear in the display. Encoder 2 is not in use with this application.

The scaling parameters F07.066 and F07.067 are automatically set to the appropriate values with this application. Parameter F07.068 allows setting a core diameter.

When set to zero, the display will show the full roll diameter.

When set to a core diameter, the display will show the remaining material diameter (full diameter – core diameter).

Besides the total material length and the actual diameter the unit also records the extreme diameter values (minimum and maximum) coming up during the process.

Presets K1 and K2 are related to the actual line counter of encoder 1 (total material length under the measuring roll).

Presets K3 and K4 are related to the actual diameter value of the winding roll.

	Display	L1 (red)	L2 (yellow)
1	Actual roll diameter	--	--
2	Minimum diameter (since last reset)	blinking fast	--
3	Maximum diameter (since last reset)	--	blinking fast
4	Actual value of the line counter	blinking slow	--
5	Last counting result of the line counter	--	blinking slow

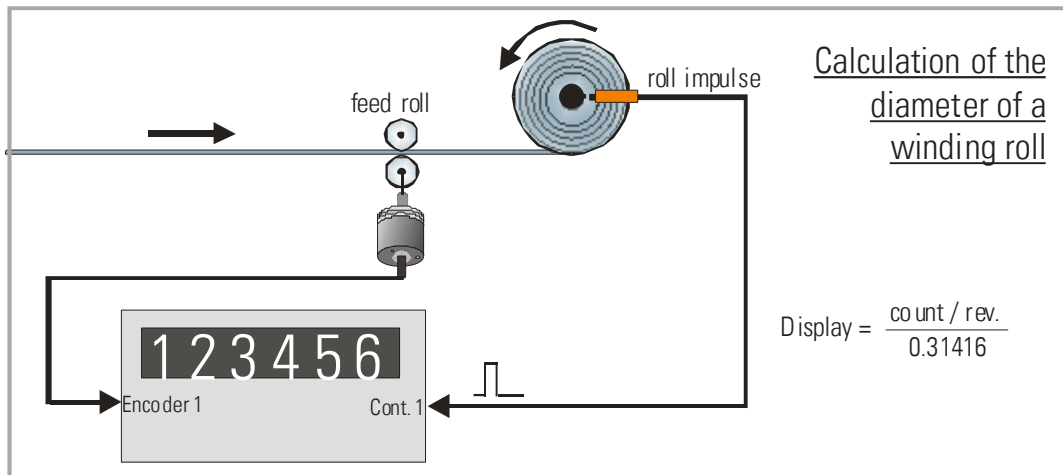

## 4.7. Radius Calculation with Winding Rolls: F07.062 = 6

With this mode encoder 1 receives line impulses from a measuring wheel or a feed roll of a winder or unwinder application. Furthermore the counter needs one trigger impulse from the rotation of the winding roll. From both signals the counter can calculate and display the actual radius of the roll. All counting occurs in the background and only updated diameter readings appear in the display. Encoder 2 is not in use with this application.

The scaling parameters F07.066 and F07.067 are automatically set to the appropriate values with this application. Parameter F07.068 allows setting a core radius.

When set to zero, the display will show the full radius of the roll.

When set to a core radius, the display will show the remaining radius of the material (full radius – core radius).

Besides the total material length and the actual radius the unit also records the extreme radius values (minimum and maximum) coming up during the process.

Presets K1 and K2 are related to the actual line counter of encoder 1 (total material length under the measuring roll).

Presets K3 and K4 are related to the actual radius value of the winding roll.

	Display	L1 (red)	L2 (yellow)
1	Actual roll radius	--	--
2	Minimum radius (since last reset)	blinking fast	--
3	Maximum radius (since last reset)	--	blinking fast
4	Actual value of the line counter	blinking slow	--
5	Last counting result of the line counter	--	blinking slow

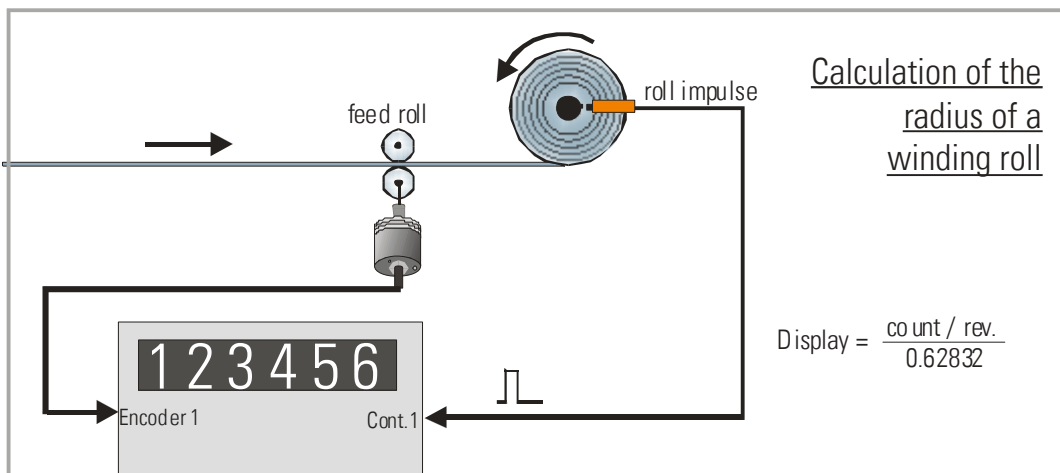

## 4.8. Cut-to-Length Control Counter: F07.062 = 7 or 8

The cut-to-length function described here requires the use of a counter model possessing at least two front thumbwheel switches.

Modes 7 and 8 serve for control of cut-to-length applications with line drives providing a fast – slow – stop speed profile. The table below explains which functions are assigned to the thumbwheels and preset registers

Preset	Function	Explanation
Thumbwheel 1	<b>Tool Width</b>	Compensates the cutting length setting by the width of the saw blade or cutting tool
Thumbwheel 2	<b>Cutting Length</b>	Desired total length of the piece to cut
Preset register F01.004 (keypad entry)	<b>Pre-Stop</b>	Anticipation distance where the speed changes from high to low before reaching the final position.
Preset register F01.005 (keypad entry)	<b>Correction Stop</b>	Correction of the overshoot distance which the drive produces when changing from low speed to stop

Preselection registers K1 to K4 (F01.000 to F01.003) are not available for any settings, since this application uses the same registers for calculations and intermediate results.

With operation mode F07.062 set to 7, the counter starts from zero and counts up until reaching the value of "Cutting Length plus Tool Width". With operation mode F07.062 set to 8, the start signal presets the counter to the negative value of the Tool Width, from where the counter counts up until it reaches "Cutting Length"

All other functions are fully similar with these two modes.

This mode provides display of the actual position only and also the analogue output (if applicable) is assigned to the actual counter value.

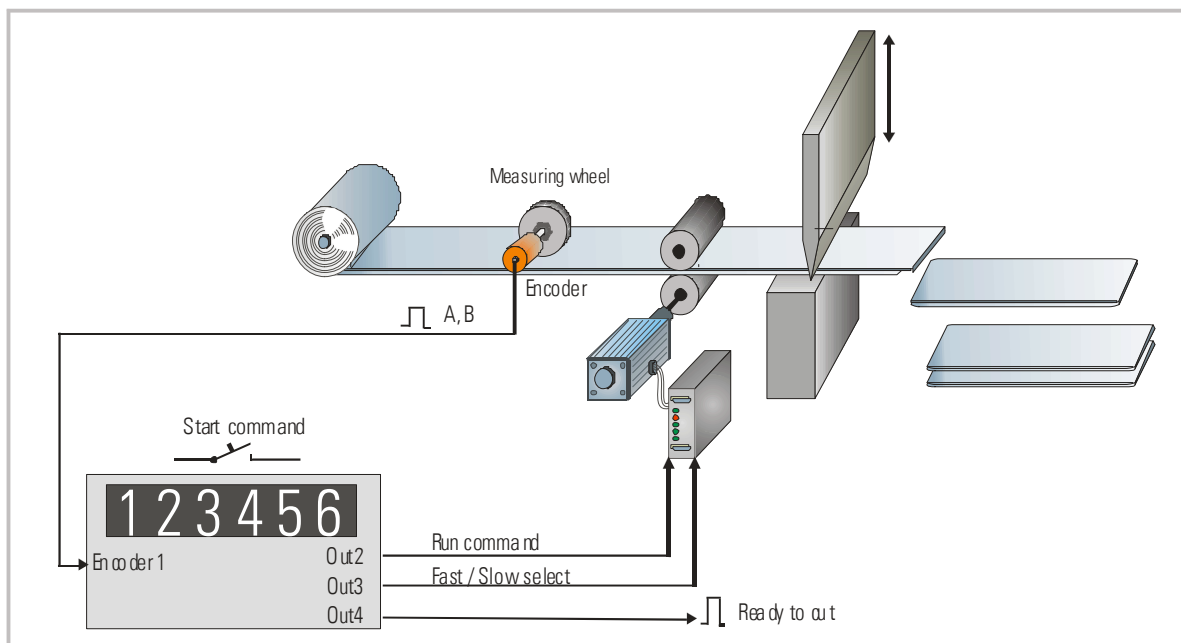

The Start command can be assigned to any of the front keys or to or to any of the Control Inputs, by attaching the RESET function to it (e.g. set parameter F06.052 to 1 to assign the Start function to the ENTER key etc.). Also an automatic reset function with a timed output signal can be used, in order to ensure automatic stepping of the cutting sequence without a remote start signal.

The diagram below shows the switching states of outputs 2, 3 and 4 with respect to above parameters. Output 1 must not be used with this application.

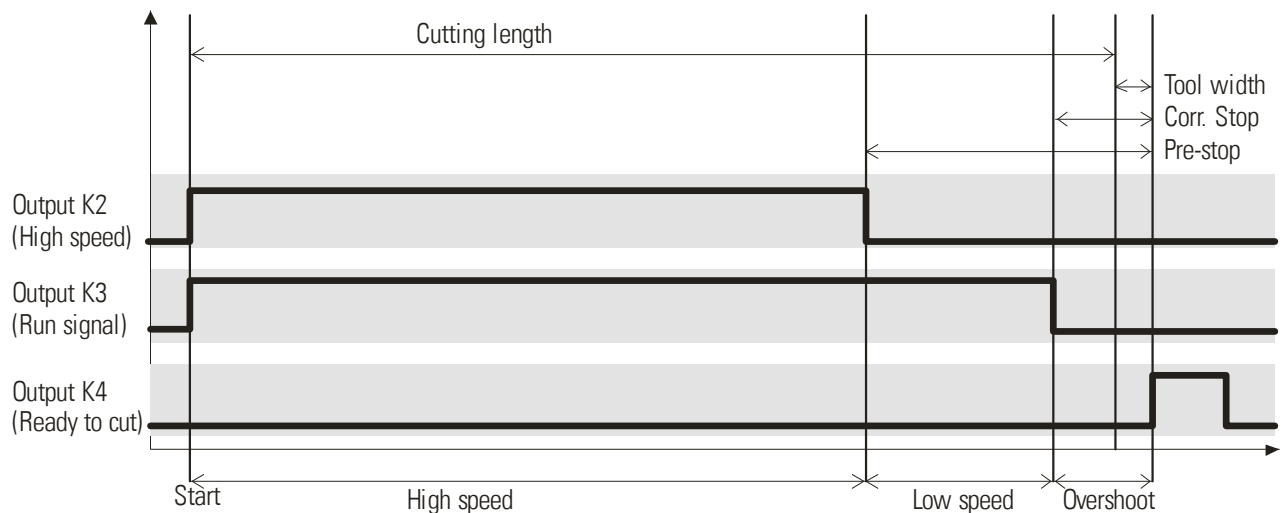

The functions and switching characteristics shown above require the following parameter settings:

- F10.101 = 1 (preset counter to Preselections)
- F10.090 = 0 (Output K2 static)
- F10.098 = 1 (Output K2 active when count  $\leq$  preset)
- F10.091 = 0 (Output K3 static)
- F10.099 = 1 (Output K3 active when count  $\leq$  preset)
- F10.092 = x (Output K4 static or dynamic according to need)
- F10.100 = 0 (Output K4 active when count  $\geq$  preset)

## 4.9. Monitor for Slip, Torsion, Skew Position, Shaft Fracture:

### F07.062 = 9

This counter mode is a special version of the Differential Counter described previously. As a major difference, in this mode all four presets and outputs (K1 – K4) refer exclusively to the differential count, and also a programmable slip function has been added.

Before forming the difference, each of the two encoder inputs is scaled individually according to the setting of the impulse scaling factor. If applicable, the differential result can once more be scaled to engineering units with use of the final scaling operands.

Since presets and outputs can be set to positive and negative values as well, it is also possible to use the unit for simple synchronous control purpose of two drives, by temporary accelerating or breaking one of the drives when lagging or leading the other. Typical examples are large rolling gates or lifting ramps or gantry cranes, driven by several independent motors.

Some applications (e.g. with couplings) can accept (or even may require) a certain slip. For slip control with adjustable slip parameters, an automatic timer function can be programmed to reset the counters periodically.

Multi-purpose parameter F04.030 is used to set the reset cycle in seconds (00.0 = no automatic reset, 99.9 = reset every 99.9 seconds)

Since with slip applications, where the automatic reset function is switched on, the real time display of the counter may be very confusing, multi-purpose parameter F04.031 works to reduce the update rate of the display

(0 = real-time display, 1 = 8 msec., 2 = 16 msec., 3 = 32 msec., 4 = 64 msec. etc.)

Besides the differential count, the display can be scrolled to indicate also the following values:

	Display	L1 (red)	L2 (yellow)
1	Differential count (encoder1 – encoder2)	--	--
2	Minimum difference (since last reset)	blinking fast	--
3	Maximum difference (since last reset)	--	blinking fast
4	Encoder 1 only	blinking slow	--
5	Encoder 2 only	--	blinking slow

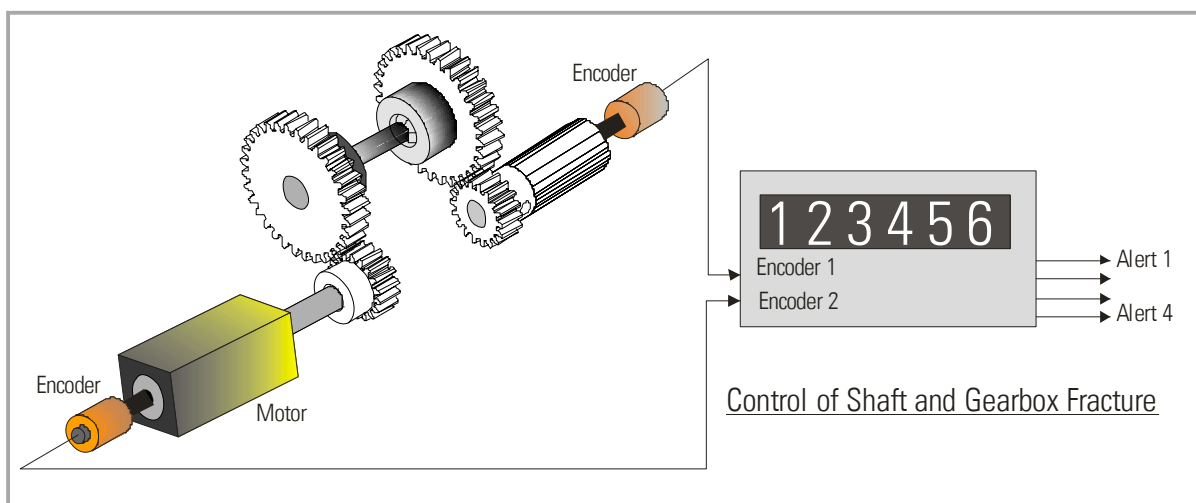

## 4.10. Dual Counter, Two Independent Counters for Encoders 1 and 2: F07.062 = 10

Both encoder inputs operate fully independent one from the other, with individual scaling, evaluation and display. Also each counter can be set or reset individually.

Both counters are treated equally, except with recording of minimum and maximum values. With regard to this function one of the two counters has to be declared as the "main counter".

The unit will record the min/max values of the main counter only and no min/max values will be available of the other counter.

Attribution of the main counter uses the Multi-Purpose Parameter 1 (F04.030)

F04.030 = 0 : Encoder 1 represents the main counter (default)  
F04.030 = 1 : Encoder 2 represents the main counter

Presets K1 and K2 are always related to the main counter.

Presets K3 and K4 refer to the other of the two counters

With many applications it may be desirable to toggle the display only between encoder 1 and encoder 2, without needing to pass over all the other values every time. Therefore the Multi-Purpose Parameter 2 (F04.031) can be used to choose between one of the following two display sequences:

F04.031 = 0 : Standard display sequence with all display values\* (default)

	Display	L1 (red)	L2 (yellow)
1	Main counter (encoder 1 or encoder 2)	--	--
2	Minimum value of main counter (since last reset)	blinking fast	--
3	Maximum value of main counter (since last reset)	--	blinking fast
4	Counter of encoder 1	blinking slow	--
5	Counter of encoder 2	--	blinking slow

F04.031 = 1 : Short display sequence to toggle between encoders 1 and 2 only

	Display	L1 (red)	L2 (yellow)
1	Counter of encoder 1	blinking slow	--
2	Counter of encoder 2	--	blinking slow







\*) Units with analogue output (ZA series) will always generate the analogue signal from one of the lines 1 to 5, according to assignment by parameter F08.079. This is also valid when the short display sequence is used.

# 5. Keypad Operation

An overview of all parameters and explanations can be found under section 6.

The menu of the unit uses four keys, hereinafter named as follows:

			
PROG	UP	DOWN	ENTER

Key functions depend on the actual operating state of the unit. Essentially we have to describe three basic states:

- Normal operation
- General setup procedure
- Direct fast access to presets and set values

## 5.1. Normal Operation











In this mode the unit operates as a counter according to the settings defined upon setup. All front keys may have customer-defined functions according to the specifications met in the keypad definition menu F06 (e.g. scrolling of the display, Reset, Inhibit etc.)

## 5.2. General Setup Procedure

The unit changes over from normal operation to setup level when keeping the  key down for at least 2 seconds. Thereafter you can select one of the parameter groups F01 to F13.

Inside the group you can now select the desired parameter and set the value according to need. After this you can either set more parameters or return to the normal operation.

The adjoining sequence of key operations explains how to change **Parameter number 052 of group F06 from the original value of 0 to 8**

Step	State	Key action	Display	Comment
00	Normal operation		Counting	
01		 > 2 sec.	F01	Display of the Parameter group
02	Level: Parameter group	 5 x	F02 ... F06	Select group # F06
03			F06.050	Confirmation of F06. The first parameter of this group is F06.050
04	Level: Parameter numbers	 2 x	F06.051 ... F06.052	Select parameter 052
05			0	Parameter 052 appears in display, actual setting is 0
06	Level: Parameter values	 8 x	1 .... 8	Setting has been modified from 0 to 8
07			F06.052	Save the new setting (8)
08	Level: Parameter numbers		F06	Return to level parameter groups
09	Level: Parameter groups		Counting	Return to normal operation
10	Normal operation			
		 <p>During the general setup procedure all counter activities remain disabled. New parameter settings become active after return to normal operation only.</p>		

### 5.3. Direct Fast Access to Presets

To get to the fast access routine, please press both

 and  at the same time





This will access the parameter group F01 right away. To change of the settings follow the same procedure as already described above. Besides the advantage of direct access, the fundamental difference to general setup is the following:

 <p>During the fast access procedure all counter functions remain fully active. Access is limited to presets; no other parameters can be changed.</p>
--













## 5.4. Change of Parameter Values on the Numeric Level

The numeric range of the parameters is up to 6 digits with 6-decade models and up to 8 digits with 8 decade models. Some of the parameters may also include a sign. For fast and easy setting of these values the menu uses an algorithm as shown subsequently. During this operation the front keys have the following functions:

			
PROG	UP	DOWN	ENTER
Saves the actual value shown in the display and returns to the parameter selection level	Increments the highlighted (blinking) digit	Decrements the highlighted (blinking) digit	Shifts the cursor (blinking digit) one position to the left, or from utmost left to right

With signed parameters the left digit scrolls from **0 to 9** and then shows “-„ (negative) and “-1” (minus one). The example below shows how to change a parameter from the setting 1024 to the new setting 250 000 (using a 6 decade model).

This example assumes that you have already selected the parameter group and the parameter number, and that you actually read the parameter value in the display. Highlighted digits appear on colored background.

Step	Display	Key action	Comment
00	001024		Display of actual parameter setting, last digit is highlighted
01		 4 x	Scroll last digit down to 0
02	001020		Shift cursor to left
03	001020	 2 x	Scroll highlighted digit down to 0
04	001000	 2 x	Shift cursor 2 positions left
05	001000		Scroll highlighted digit down to 0
06	000000		Shift cursor left
07	000000	 5 x	Scroll highlighted digit up to 5
08	050000		Shift cursor left
09	050000	 2 x	Scroll highlighted digit up to 2
10	250000		Save new setting and return to the parameter number level

## 5.5. Code Protection against Unauthorized Keypad Access

Parameter group F05 allows to define an own locking code for each of the parameter menus. This permits to limit access to certain parameter groups to specific persons only.

When accessing a protected parameter group, the display will first show "CODE" and wait for your entry. To continue keypad operations you must now enter the code which you have stored before, otherwise the unit will return to normal operation again.

After entering your code, press the ENTER key and keep it down until the unit responds. When your code was correct, the response will be "YES" and the menu will work normally. With incorrect code the response will be "NO" and the menu remains locked.

## 5.6. Return from the Programming Levels and Time-Out Function



At any time the PROG key sets the menu one level up and finally returns to normal operation. The same step occurs automatically via the time-out function, when during a period of 10 seconds no key has been touched.

Termination of the menu by automatic time-out will not store new settings, unless they have already been stored by the PROG key after editing.

## 5.7. Reset all Parameters to Factory Default Values

Upon special need it may be desirable to set all parameters back to their original factory settings (e.g. because you have forgotten your access code, or by too many change of settings you have achieved a complex parameter state). Default values are indicated in the parameter tables shown later.

To reset the unit to default, please take the following steps:

- Switch power off
- Press  and  simultaneously
- Switch power on while you keep down both keys



Where you decide to take this action, please note that all parameters and settings will be lost, and that you will need to run a new setup procedure again.

# 6. Menu Structure and Description of Parameters

All parameters are arranged in a reasonable order of functional groups (F01 to F13)  
 You must only set those parameters which are really relevant for your specific application.  
 Unused parameters can remain as they actually are.

## 6.1. Summary of the Menu

This section shows a summary of the parameter groups, with an assignment to the functional parts of the unit.

Group	Function	Group	Function
<b>F01</b>	<b>Preselection values</b>	<b>F02</b>	<b>Definitions for encoder 1</b>
000	Preselection K1	010	Encoder properties
001	Preselection K2	011	Edge count select x1, x2, x4
002	Preselection K3	012	Counting direction up/down
003	Preselection K4	013	Impulse scaling Factor
004	Preset value encoder 1	014	Multiple count factor
005	Preset value encoder 2	015	Round-loop cycle definition
<b>F03</b>	<b>Definitions for encoder 2</b>	<b>F04</b>	<b>Special functions</b>
018	Encoder properties	026	Digital input filters
019	Edge count select x1, x2, x4	027	Power down memory
020	Counting direction up/down	028	Input threshold 1
021	Impulse scaling Factor	029	Input threshold 2
022	Multiple count factor	030	Multi-purpose parameter (1)
023	Round-loop cycle definition	031	Multi-purpose parameter (2)
<b>F05</b>	<b>Keypad protection codes</b>	<b>F06</b>	<b>Key commands and control inputs</b>
033	F01	050	Key UP
034	F02	051	Key DOWN
035	F03	052	Key ENTER
036	F04	053	Input Cont.1, switching characteristics
037	F05	054	Input Cont.1, assignment of function
038	F06	055	Input Cont.2, switching characteristics
039	F07	056	Input Cont.2, assignment of function
040	F08	057	Input Cont.3, switching characteristics
041	F09	058	Input Cont.3, assignment of function
042	F10	059	Input Cont.4, switching characteristics
043	F11	060	Input Cont.4, assignment of function
044	F12		
045	F13		

Group	Function
<b>F07</b>	<b>Basic settings</b>
062	Mode of operation
063	Decimal point encoder 1
064	Decimal point encoder 2
065	Decimal point combined <1,2>
066	Multiplication factor <1,2>
067	Division factor <1,2>
068	Display offset <1,2>
069	Brightness of LED display %
070	Display Update Time

Group	Function
<b>F09</b>	<b>Serial communication</b>
081	Serial device address
082	Baud rate
083	Data format
084	Serial protocol selection
085	Timer for auto-transmission
086	Serial code for transmission

Group	Function
<b>F08</b>	<b>Analogue output definitions (ZA only)</b>
074	Output current or voltage
075	Start value of conversion
076	End value of conversion
077	Output swing
078	Zero offset
079	Assignment of the Analogue Output

Group	Function
<b>F10</b>	<b>Switching features and presets</b>
089	K1 (static or pulse)
090	K2 (static or pulse)
091	K3 (static or pulse)
092	K4 (static or pulse)
093	Hysteresis K1
094	Hysteresis K2
095	Hysteresis K3
096	Hysteresis K4
097	Preselection mode K1
098	Preselection mode K2
099	Preselection mode K3
100	Preselection mode K4
101	Preset mode
102	Output polarity
103	Sign of thumbwheel switch (ZD6...)
104	Thumbwheel assignment
105	Start-up Inhibit for Outputs
106	Calculation of trailing preselections

F11	Mode of Linearisation
F11.108	Linearisation mode counter 1
F11.109	Linearisation mode counter 2

F12	Table of Linearisation Counter 1
F12.114	First interpolation point (x1 value)
F12.115	First interpolation point (y1 value)
etc. ----->	
F12.144	Last interpolation point (x16 value)
F12.145	Last interpolation point (y16 value)

F13	Table of Linearisation Counter 2
F13.146	First interpolation point (x1 value)
F13.147	First interpolation point (y1 value)
etc. ----->	
F13.176	Last interpolation point (x16 value)
F13.177	Last interpolation point (y16 value)

The following schematics shows how in principle the parameter blocks are assigned to the various elements and functions of the counter.

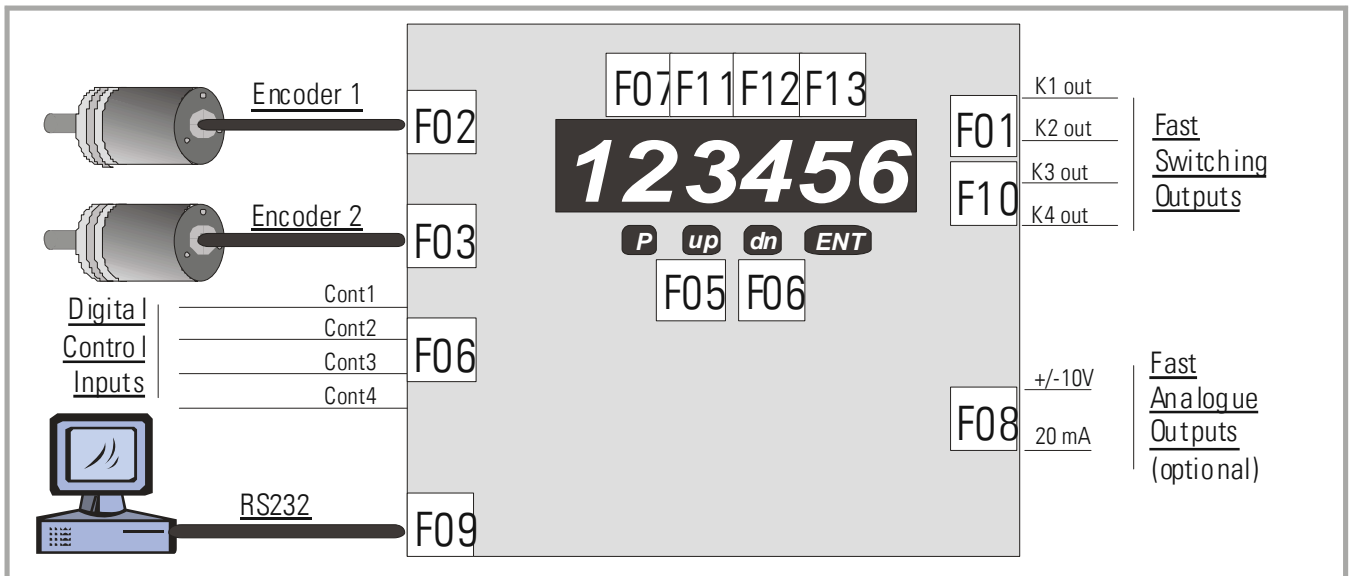

Where you find **highlighted indications** in the following parameter listings, this indicates that the setting range depends on the model and is 6 digits with 6 decade models and 8 digits with 8 decade models

## 6.2. Description of the Parameters

### 6.2.1. Preselections and presets

F01		Range	Default	Ser.
000	Preselection K1	-199 999 - 999 999	1 000	00
001	Preselection K2	-199 999 - 999 999	2 000	01
002	Preselection K3	-199 999 - 999 999	3 000	02
003	Preselection K4	-199 999 - 999 999	4 000	03
004	Preset value encoder 1	-199 999 - 999 999	000 000	04
	Upon internal or external command the encoder 1 counter will set to this value			
005	Preset value encoder 2	-199 999 - 999 999	000 000	05
	Upon internal or external command the encoder 2 counter will set to this value			

### 6.2.2. Definitions for encoder 1

F02		Range	Default	Ser.
010	Encoder properties	0 ... 3	1	A0
	0= Differential signals A, /A, B, /B (2 x 90° *)			
	1= HTL signals A, B (2 x 90°) single-ended			
	2= Differential signals A, /A for count *) Differential signals B, /B to indicate static direction (if available)			
	3= HTL signal A (single-ended) for count HTL signal B (single-ended) to indicate static direction (if available)			
011	Edge counting	0 ... 2	0	A1
	0= Simple (x1)			
	1= Double (x2)			
	2= Full quadrature (x4)			
012	Counting direction	0 ... 1	0	A2
	0= Up when A leads B			
	1= Down when A leads B			
013	Impulse scaling factor	0.00001 - 9.99999	1.00000	A3
	Multiplier for input impulses			
014	Impulse multiplier	001 - 99	001	A4
	Multiple count of every impulse			
015	Round-loop cycle	0 - 999 999	0	A5
	0= Unlimited counting range			
	xxx Round-loop operation in a range 0 - xxx			

\*) Applies for any kind of differential signals, no matter if RS422 or TTL level or HTL level

### 6.2.3. Definitions for encoder 2

F03		Range	Default	Ser.
018	Encoder properties	0 ... 3	1	A8
	0= Differential signals A, /A, B, /B (2 x 90°) *)			
	1= HTL signals A, B (2 x 90°) single-ended			
	2= Differential signals A, /A for count *) Differential signals B, /B to indicate static direction (if available)			
	3= HTL signal A (single-ended) for count HTL signal B (single-ended) to indicate static direction (if available)			
019	Edge counting	0 ... 2	0	A9
	0= Simple (x1)			
	1= Double (x2)			
	2= Full quadrature (x4)			
020	Counting direction	0 ... 1	0	B0
	0= Up when A leads B			
	1= Down when A leads B			
021	Impulse scaling factor	0.00001 - 9.99999	1.00000	B1
	Multiplier for input impulses			
022	Impulse multiplier	001 - 99	001	B2
	Multiple count of every impulse			
023	Round-loop cycle	0 - 999 999	0	B3
	0= Unlimited counting range			
	xxx Round-loop operation in a range 0 - xxx			

\*) Applies for any kind of differential signals, no matter if RS422 or TTL level or HTL level

### 6.2.4. Special functions

F04		Range	Default	Ser.
026	Digital input filter	0 ... 3	0	B6
027	Power-down memory	0 - 1	0	B7
	0= Off. Counter resets to zero after power down			
	1= On. Counter stores last counting result			
028	Trigger threshold for encoder1 inputs (**)	30 ... 250	166	B8
029	Trigger threshold for encoder2 inputs (**)	30 ... 250	166	B9
030	Multi-purpose parameter, function depending on application as shown under 4.1, 4.9, 4.10, 6.3	0 ... 999	0	C0
031	Multi-purpose parameter, function depending on application as shown under 4.9, 4.10	0 ... 999	0	C1

\*\*\*) Must be set to the default value (166) with any kind of input signals, except if exceptionally single-ended TTL signals should be used. Only in this case setting 35 is required.

### 6.2.5. Keypad protection codes

F05	Range	Default	Ser.
033 Protected group F01	0 = no protection  1 – 999 999 = Protection code for the actual group	0	C3
034 Protected group F02		0	C4
035 Protected group F03		0	C5
036 Protected group F04		6079	C6
037 Protected group F05		0	C7
038 Protected group F06		0	C8
039 Protected group F07		0	C9
040 Protected group F08		0	D0
041 Protected group F09		0	D1
042 Protected group F10		0	D2
043 Protected group F11		0	D3
044 Protected group F12		0	D4
045 Protected group F13		0	D5

### 6.2.6. Key commands and control input definitions

F06	Range	Default	Ser.
050 Function assignment to key „UP“	0 ... 14	0	E0
0= No function			
1= Reset counter 1 (encoder 1) and read **) (Clears also points of change of direction)			
2= Reset counter 2 (encoder 2) and read **)			
3= Reset counter 1 and counter 2 and read **)			
4= Set counter 1 to Set Value 1 *) **)			
5= Set counter 2 to Set Value 2 *) **)			
6= Set both counters to Set Value *) **)			
7= Inhibit counter 1 and read **)			
8= Inhibit counter 2 and read **)			
9= Read front thumbwheels (models 6xx only) **)			
10= Start serial transmission			
11= Reset minimum/maximum records			
12= Scroll actual display			
13= Special command (depends on counter mode)			
14= n.a.			
051 Function assignment to key „DOWN“	0 ... 14	0	E1
See key „UP“			
052 Function assignment to key „ENTER“	0 ... 14	0	E2
See key „UP“			

\*) Parameter F10.101 defines the source of the Set Value (see 6.3)

\*\*) "Read" refers to models 6xx with thumbwheel switches only. See appendix.



F06 (continued)	Range	Default	Ser.
053 Switching characteristics of input „Cont.1“ 0= NPN (switch to -) function active LOW 1= NPN (switch to -) function active HIGH 2= NPN (switch to -) rising edge 3= NPN (switch to -) falling edge 4= PNP (switch to +), function active LOW 5= PNP (switch to +), function active HIGH 6= PNP (switch to +), rising edge 7= PNP (switch to +), falling edge	0 ... 7	0	E3
054 Function assignment to input „Cont.1“ 0= No function 1= Reset counter 1 (encoder 1) and read **) (Clears also points of change of direction) 2= Reset counter 2 (encoder 2) and read **) 3= Reset counter 1 and counter 2 and read **) 4= Set counter 1 to Set Value 1 *) **) 5= Set counter 2 to Set Value 2 *) **) 6= Set both counters to Set Value *) **) 7= Inhibit counter 1 and read **) 8= Inhibit counter 2 and read **) 9= Read only **) 10= Start serial transmission 11= Reset minimum/maximum records 12= Scroll actual display 13= Special command (depends on counter mode) 14= Hardware keypad interlock	0 ... 14	0	E4
055 Switching characteristics of input „Cont.2“ See „Cont.1“ (F06.053)	0 ... 7	0	E5
056 Function assignment to input „Cont.2“ See „Cont.1“ (F06.054)	0 ... 14	0	E6
057 Switching characteristics of input „Cont.3“ See „Cont.1“ (F06.053)	0 ... 7	0	E7
058 Function assignment to input „Cont.3“ See „Cont.1“ (F06.054)	0 ... 14	0	E8
059 Switching characteristics of input „Cont.4“ 0 = = NPN (switch to -), active LOW 1 = = NPN (switch to -), active HIGH 2 = = PNP (switch to +), active LOW 3 = = PNP (switch to +), active HIGH	0 ... 3  static switching functions only	0	E9
060 Function assignment to input „Cont.4“ See „Cont.1“ (F06.054)	0 ... 14	0	F0



**Unconnected NPN inputs are always HIGH (internal pull-up resistor)**  
**Unconnected PNP inputs are always LOW (internal pull-down resistor)**

\*) Parameter F10.101 defines the source of the Set Value (see 6.3)

\*\*) "Read" refers to models 6xx with thumbwheel switches only. See appendix.

## 6.2.7. Basic settings

F07		Range	Default	Ser.
062	Operation mode of the counter 0= „Single“, encoder 1 only 1= „Sum“, encoder 1 + encoder 2 2= „Differential“, encoder 1 – encoder 2 3= Master counter and batch counter 4= Measuring of real cutting length 5= Calculation of roll diameters 6= Calculation of roll radius 7= Cut-to-length control 8= Cut-to-length control 9= Slip-, torsion- skew position monitor 10= Dual counter, independent counters 1 and 2	0 ... 10	0	F2
063	Decimal point position of encoder 1	0 ... 5	0	F3
064	Decimal point position of encoder 2	0 ... 5	0	F4
065	Decimal point position combined <1&2>	0 ... 5	0	F5
066	Scaling factor for combined values <1&2>	0.0001 – 9.9999	1.0000	F6
067	Divider for combined values*	0.0000 – 9.9999	0	F7
068	Offset value for combined values	-199999 - 999999	0	F8
069	Brightness of the 7-segment LED display 0= 100% of maximum brightness 1= 80% of maximum brightness 2= 60% of maximum brightness 3= 40% of maximum brightness 4= 20% of maximum brightness	0 ... 4	0	F9
070	Display Update Time (sec.)	0.005 - 9.999	0.005	G0

## 6.2.8. Analogue output definitions (ZA models only)

F08		Range	Default	Ser.
074	Output format 0= Voltage – 10 V... + 10 V 1= Voltage 0 ..... +10 V 2= Current 4 – 20 mA 3= Current 0 – 20 mA	0 ... 3	0	G4
075	Beginning of the conversion range Display value to generate 0 volts or 0/4 mA	-199999 - 999999	0	G5
076	End of the conversion range Display value to generate 10 volts or 20 mA	-199999 - 999999	10 000	G6
077	Analogue output swing (1000 = 10 V or 20 mA)	0 ... 1000	1000	G7
078	Analogue zero offset (mV, zero displacement)	-10000 - 10000	0	G8
079	Analogue output assignment (according to lines 1 – 5 of the display scrolling function)	0 ... 4 (Line1) ... (Line5)		G9

\*) Setting 0,0000 will skip the whole recalculation and therefore speed up the cycle time

### 6.2.9. Serial communication parameters

F09		Range	Default	Ser.
081	Serial device address (unit number)	11 ... 99	11	90
082	Serial baud rate	0 ... 6	0	91
	0= 9600 Baud			
	1= 4800 Baud			
	2= 2400 Baud			
	3= 1200 Baud			
	4= 600 Baud			
	5= 19200 Baud			
	6= 38400 Baud			
083	Serial data format	0 ... 9	0	92
	0= 7 Data, Parity even, 1 Stop			
	1= 7 Data, Parity even, 2 Stop			
	2= 7 Data, Parity odd, 1 Stop			
	3= 7 Data, Parity odd, 2 Stop			
	4= 7 Data, no Parity, 1 Stop			
	5= 7 Data, no Parity, 2 Stop			
	6= 8 Data, Parity even, 1 Stop			
	7= 8 Data, Parity odd, 1 Stop			
	8= 8 Data, no Parity, 1 Stop			
	9= 8 Data, no Parity, 2 Stop			
084	Serial protocol select *)	0 ... 1	1	H1
	0= Transmission = Unit Nr. – Data, LF, CR			
	1= Transmission = Data, LF, CR			
085	Serial timer (sec.) for timer transmissions *)	0.000 ... 99.999	0	H2
086	Serial register code of the transmit parameter *)	0 ... 19	14	H3

\*) for more details please see appendix in section 8

### 6.2.10. Switching characteristics and presets

F10		Range	Default	Ser.
089	Pulse time (sec.) output K1 (0 = static output)	0.00 ... 9.99	0.00	H6
090	Pulse time (sec.) output K2 (0 = static output)			H7
091	Pulse time (sec.) output K3 (0 = static output)			H8
092	Pulse time (sec.) output K4 (0 = static output)			H9
093	Switching hysteresis K1 (display units) *)	0 ... 9999	0	I0
094	Switching hysteresis K2 (display units) *)			I1
095	Switching hysteresis K3 (display units) *)			I2
096	Switching hysteresis K4 (display units) *)			I3

\*) The switching point equals to the preset value and the return point is displaced by the hysteresis setting

F10		Range	Default	Ser.
097	Switching characteristics K1 0= active with display $\geq$ preselection 1= active with display $\leq$ preselection 2= active with display $\geq$ preselection, 0→counter. Remaining errors are cancelled 3= active with display $\leq$ preselection, Set→counter. Remaining errors are cancelled 4= active with display $\geq$ preselection, 0→counter Remaining errors added to following cycle 5= active with display $\leq$ preselection, Set→counter Remaining errors added to following cycle	0 ... 5  <u>Remark:</u> $\geq$ and $\leq$ refer to positive values and are inversely with negative values	0	14
098	Switching characteristics K2 (see K1, F10.097)	0 ... 5	0	15
099	Switching characteristics K3 (see K1, F10.097)			16
100	Switching characteristics K4 (see K1, F10.097)			17
101	Set value of the counter 0= Set value = Preset (1 or. 2) 1= Set value = Preselection K1 or K2	0 ... 1	0	18
102	K1 – K4 outputs N.C or N.O *) K1= binary value 1 K2= binary value 2 K3= binary value 4 K4= binary value 8 Bit = 0: Output switches ON when active (N.O.) *) Bit = 1: Output switches OFF when active (N.C.) *)	0 ... 15  <u>Example:</u> Setting 9 means that K1 and K4 operate N.O. and K2 and K3 operate N.C *)	0	19
103	Sign of thumbwheel switches (models ZD6xx only)	see appendix	0	J0
104	Thumbwheel switch assignment (models ZD6xx only)	see appendix	0	Q1
105	Start-up Inhibit of timed K1-K4 outputs after power-up	0 = pulses enabled 1 = pulses disabled	0	Q2
106	Switch point calculation with trailing preselections 0: K1=>K1, K2=>K2, K3=>K3, K4=>K4 1: K1=>K1, K1-K2=>K2, K3=>K3, K4=>K4 2: K1=>K1, K2=>K2, K3=>K3, K3-K4=>K4 3: K1=>K1, K1-K2=>K2, K3=>K3, K3-K4=>K4  Example: if set to "1" the K2 switching point would be substituted by the difference K1 - K2 (i.e. F00.000 - F00.001)	0 ... 3	0	Q3



\*) **N.O.** means "normally open", saying that the corresponding output is normally switched OFF and will switch on when the assigned event happens.

\*) **N.C.** means "normally closed", saying that the corresponding output is normally switched ON and will switch off when the assigned event happens

### 6.2.11. Parameters for Linearisation

F11	Modes of Linearisation	Range	Default	Ser.
108	Mode of linearization for counter 1 (encoder 1) 0 = Linearisation off 1 = Linearisation is defined for the numeric range from 0 to +999 999 only and negative values will appear as a mirror of the positive values 2 = Linearisation is defined over the full range from -199 999 to +999 999	0 – 2  (see drawings on next page)	0	J1
109	Mode of linearization for counter 2 (encoder 2) 0 = Linearisation off 1 = Linearisation is defined for the numeric range from 0 to +999 999 only and negative values will appear as a mirror of the positive values 2 = Linearisation is defined over the full range from -199 999 to +999 999	0 – 2  (see drawings on next page)	0	J2

F12	Table of linearization for counter 1 (encoder 1)	Range	Default	Ser.
114	First interpolation point, (x0, original value)	-199999 - 999999	0	J7
115	First interpolation point, (y0, replacement value)			J8
116	Second interpolation point (x1, original value)			J9
117	Second interpolation point (y1, replacement value)			K0
	etc. ---->			
144	Last interpolation point, (x15, original value)			M7
145	First interpolation point, (y15, replacement value)			M8

F13	Table of linearization for counter 2 (encoder 2)	Range	Default	Ser.
146	First interpolation point, (x0, original value)	-199999 - 999999	0	M9
147	First interpolation point, (y0, replacement value)			N0
148	Second interpolation point (x1, original value)			N1
149	Second interpolation point (y1, replacement value)			N2
	etc. ---->			
176	Last interpolation point, (x15, original value)			P9
177	Last interpolation point, (y15, replacement value)			Q0

## 6.2.12. Hints for using the linearization function

The subsequent drawing explains the difference between the modes of linearization.

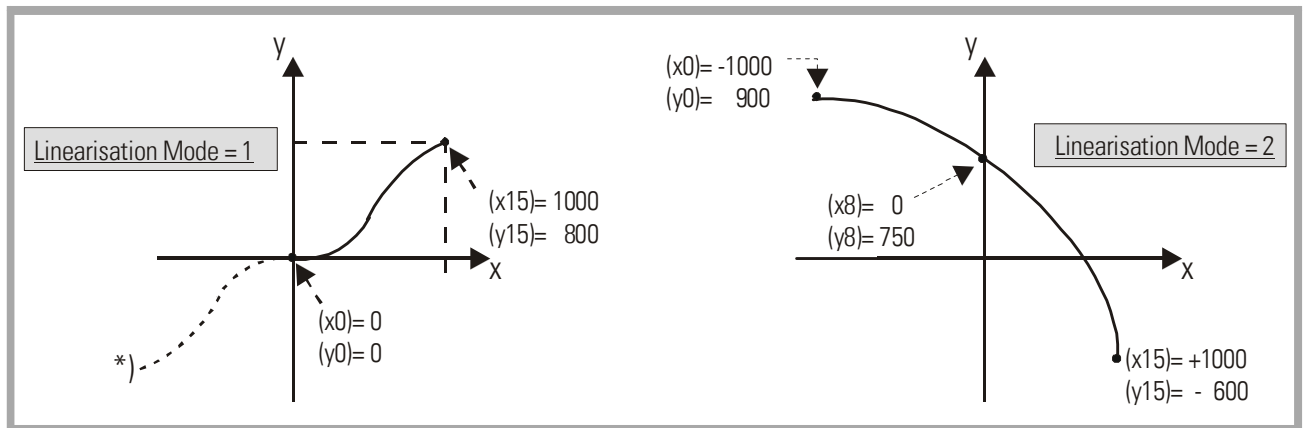

- x-registers are to set the numeric counter value that the unit would display without linearization
- y-registers are to set the numeric value that should be displayed instead (i.e. the y3 setting will replace the display value x3)
- between the interpolation points the unit automatically uses linear interpolation
- x-registers have to use continuously increasing values, e.g. the lowest display value must be set to register x0, and the highest display value must be set to x16
- Independent of the selected linearization mode, the possible setting range of all registers x0, y0, ... x16, y16 is always -199999 ... 999999.
- For measuring values outside of the defined linearization range, please note: If the measuring value is lower than x0, the linearization result will always be y0. If the measuring value is higher than x16, the linearization result will always be y16.

### 6.3. Clarification of the Counter Setting Functions

This section is only important if you intend to preset the counter to values different from zero. The menu provides several options to reset one or both of counters to zero, or to set the counters to programmable preset values.

Whilst with a reset command the data loaded into the counter is always zero, the setting procedure may load data from different locations, depending on the operating mode and some parameter settings.

The tables below are to clarify which source the counters are using under which conditions. It would not make any sense to use the preset functions with other counter modes than those shown below, therefore the tables indicate the reasonable possibilities only.

The triggering event to activate a preset action depends on your parameter settings and can be manual (front key or control input) or automatic (when the counter reaches one of the four preselection thresholds K1 to K4).

The source of the loading data can be one of the two counter preset values set to parameters F01.004 and F01.005, or any of the four preselection thresholds K1 to K4 adjusted by keypad or by front thumbwheel switches.

The target for loading data can be either counter1 or counter2

The following abbreviations are used:

<b>P1</b> = Preset value encoder 1 (F01.004)	<b>P2</b> = Preset value encoder 2 (F01.005)
<b>C1</b> = Counter 1	<b>C2</b> = Counter 2
<b>K1 ... K4</b> = Preselections (F01.000 to F01.003) or thumbwheels	<b>Man.</b> = remote set command (key or input) <b>K1auto</b> etc. = automatic set command triggered by K1

Single mode	Parameter F10.101 = 0					Parameter F10.101 = 1				
Trigger event	Man.	K1auto	K2auto	K3auto	K4auto	Man.	K1auto	K2auto	K3auto	K4auto
Counter1:	P1→C1	P1→C1	P1→C1	P2→C1	P2→C1	K1→C1	K1→C1	K2→C1	K3→C1	K4→C1

Sum mode (F07.062 = 2)	Parameter F10.101 = 0					Parameter F10.101 = 1				
Trigger event	Man.	K1auto	K2auto	K3auto	K4auto	Man.	K1auto	K2auto	K3auto	K4auto
Counter 1:	P1→C1	P1→C1	P1→C1	P1→C1	P1→C1	K1→C1	K1→C1	K2→C1	K1→C1	K2→C1
Counter 2:	P2→C2	---	---	P2→C2	P2→C2	K3→C2	---	---	K3→C2	K4→C2

Diff. mode (F07.062 = 2)	Parameter F10.101 = 0					Parameter F10.101 = 1				
Trigger event	Man.	K1auto	K2auto	K3auto	K4auto	Man.	K1auto	K2auto	K3auto	K4auto
Counter 1:	P1→C1	P1→C1	P1→C1	P1→C1	P1→C1	K1→C1	K1→C1	K2→C1	K1→C1	K2→C1
Counter 2:	P2→C2	---	---	P2→C2	P2→C2	K3→C2	---	---	K3→C2	K4→C2

Batch mode (F07.062 = 3)	Parameter F10.101 = 0					Parameter F10.101 = 1				
Trigger event	Man.	K1auto	K2auto	K3auto	K4auto	Man.	K1auto	K2auto	K3auto	K4auto
Counter 1:	P1→C1	P1→C1	P1→C1	P1→C1	P1→C1	K1→C1	K1→C1	K2→C1	*→C1	*→C1
Counter 2:	P2→C2	---	---	P2→C2	P2→C2	K3→C2	---	---	K3→C2	K4→C2

\*) no change if multi-purpose parameter F04.030 = 0, otherwise C1 cleared to zero

# 7. Appendix for models ZD/ ZA/ ZR 6xx

## 7.1. Relay Outputs

All available models are shown in section 1. While models ZD 3xx, ZA 3xx and ZR 3xx provide high-speed transistor outputs only, all models ZD 6xx, ZA 6xx and ZR 6xx provide four additional relay outputs, operating in parallel to the high-speed transistor outputs K1 – K4.

All electrical connections of 6xx models are fully similar to the 3xx models, except that with 6xx models the back plane is equipped with four additional terminal strips (3-positions each). Terminal X3 represents output K1 to output K4.

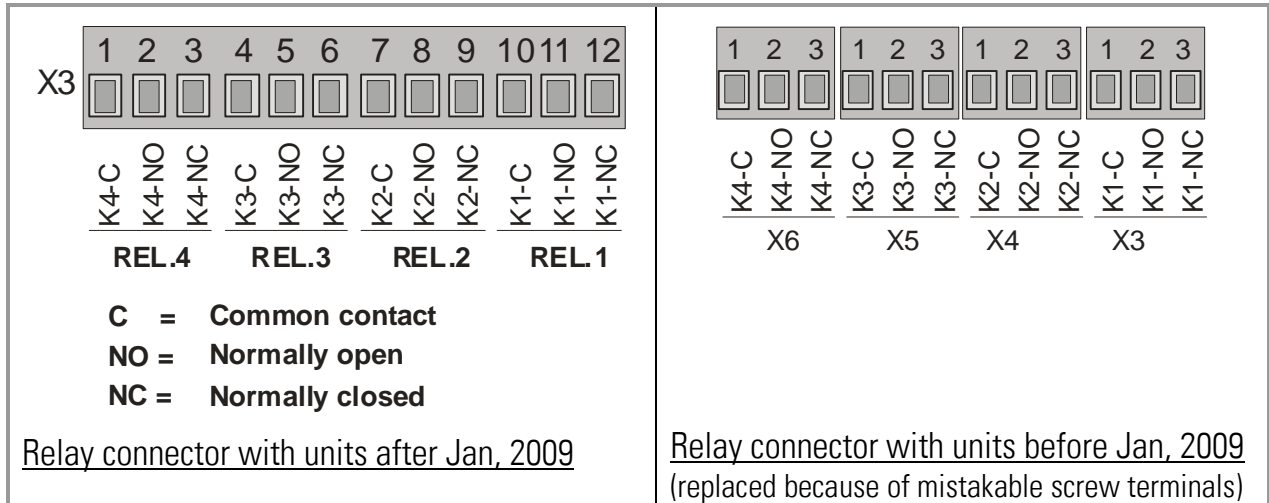

## 7.2. Front Thumbwheel Switches

Moreover, the models shown below provide thumbwheel switches on the front panel, for simple and easy setting of preselection levels. Every row allows in maximum 9 decades and one blank field for separation. The customer is free to specify any desired combination and number of decades individually, which is not wider than totally 10 spaces.

As an example, with model 642 it is possible to specify

“Set1 = 3 decades, Set2 = 6 decades”, or e.g. “Set1 = 8 decades” etc.



Where your order does not clearly state a different array of the thumbwheels, the units will be supplied with 2 x 4 decades respectively 4 x 4 decades

Models 632 and 642 can have max. 2 switch sets on front

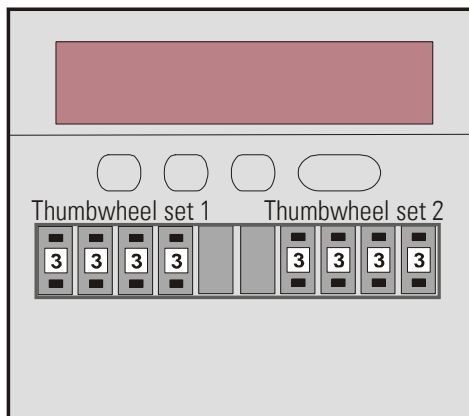

Models 634 and 644 can have max. 4 switch sets on front

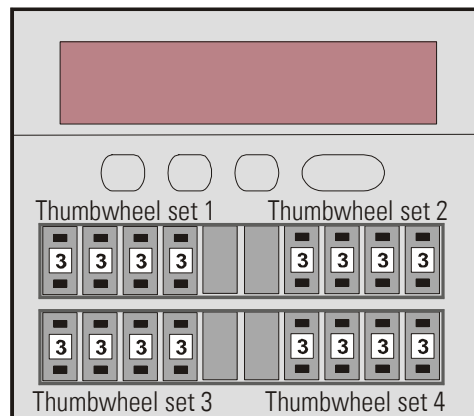



## 7.3. Specific Parameters for Units with Thumbwheel Switches

The following parameter settings apply for units with thumbwheel switches only and are not relevant for all other models:

### 7.3.1. Read and update thumbwheel switch settings

All actual thumbwheel settings are automatically considered when the unit is powered up. However, changes during normal operation will not be considered, unless upon special remote command. This can either be the actuation of one of the front keys, or a command signal to one of the control inputs.

Please see section 6.2.6 with the **parameter group F06**.



It is a “must” to assign one of the functions 1, 2, 3, 7, 8 or 9 to at least one of the front keys or one of the control inputs. These functions will read the settings of the front switches. Otherwise there will be no way to activate changes of the switch settings during operation.

Please observe if the description of your counter mode indicates any fixed occupation of control inputs 1 or 2, which then would no more be available for the thumbwheel reading function. In this case you would need to use control inputs 3 or 4 to refresh the thumbwheel settings.

### 7.3.2. Positive or negative sign of thumbwheel settings

In general and as a default, the front thumbwheel settings are assumed to have a positive sign. Some applications may however require that one or the other setting should be interpreted as a negative value.

Parameter F10.103 allows assigning negative signs to any of the front thumbwheels, following a binary schema as shown in the table below:

Setting of F10.103	00	01	02	03	04	05	06	07	08	09	10	11	12	13	14	15
Sign of Thumbwheel 1	+	-	+	-	+	-	+	-	+	-	+	-	+	-	+	-
Sign of Thumbwheel 2	+	+	-	-	+	+	-	-	+	+	-	-	+	+	-	-
Sign of Thumbwheel 3	+	+	+	+	-	-	-	-	+	+	+	+	-	-	-	-
Sign of Thumbwheel 4	+	+	+	+	+	+	+	+	-	-	-	-	-	-	-	-

### 7.3.3. Assignments between thumbwheels and switching outputs

In general and as a default, thumbwheel switch set No.1 refers to output K1; thumbwheel switch set No.2 refers to output K2 etc. This may be convenient for most of the applications, but also cause inconvenience with some operating modes of the counter.

As an example, when using the “Sum Mode” (see section 4.2), the outputs K1 and K2 are firmly attached to the encoder1 counter and outputs K3 and K4 are firmly attached to the sum of encoder1 and encoder2.

From this follows that, if you use a counter model with two sets of thumbwheels only (thumbwheel set 1 and thumbwheel set 2), you would only have preselections referring to encoder1, but no thumbwheel access to the sum.

To avoid such kind of limitations, parameter F10.104 allows free assignments between any of the thumbwheel switch sets (switch1 to switch4, see previous figure) and any of the four outputs (K1 to K4)

Setting of parameter F10.104	00	01	02	03	04	05	06	07	08	09	10	11
Thumbwheel set 1 is linked to output	K1	K1	K1	K1	K1	K1	K2	K2	K2	K2	K2	K2
Thumbwheel set 2 is linked to output	K2	K2	K3	K3	K4	K4	K1	K1	K3	K3	K4	K4
Thumbwheel set 3 is linked to output	K3	K4	K4	K2	K2	K3	K3	K4	K4	K1	K1	K3
Thumbwheel set 4 is linked to output	K4	K3	K2	K4	K3	K2	K4	K3	K1	K4	K3	K1

Setting of parameter F10.104	12	13	14	15	16	17	18	19	20	21	22	23
Thumbwheel set 1 is linked to output	K3	K3	K3	K3	K3	K3	K4	K4	K4	K4	K4	K4
Thumbwheel set 2 is linked to output	K1	K1	K2	K2	K4	K4	K1	K1	K2	K2	K3	K3
Thumbwheel set 3 is linked to output	K2	K4	K4	K1	K1	K2	K2	K3	K3	K1	K1	K2
Thumbwheel set 4 is linked to output	K4	K2	K1	K4	K2	K1	K3	K2	K1	K3	K2	K1

## 8. Appendix: Serial Communication Details

Serial communication with the counter can be used for the following purposes:

- PC setup of the counter, using the OS32 Operator software
- Automatic and cyclic transmission of counter data to remote devices like PC, PLC or Data Logger
- Communication via PC or PLC, using the communication protocol

This section describes the essential and basic communication features only. Full details are available from the special SERPRO manual.

### 8.1. Setup of the Counter by PC

Connect the counter to your PC as shown in section 3.6 of this manual. Start the OS32 Operator software. After a short initializing time you will see the following screen:

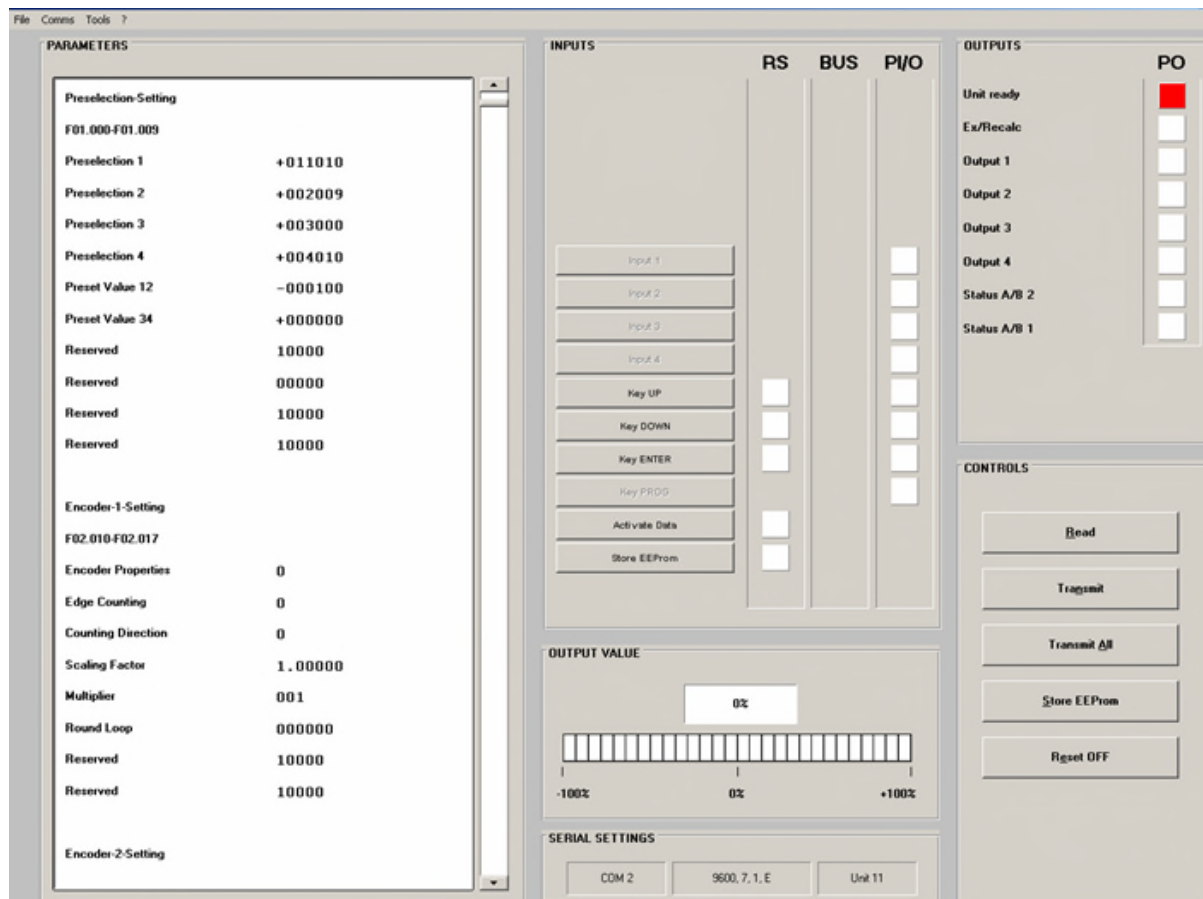

If your screen remains empty and the headline of your PC says „OFFLINE“, select „Comms“ of the menu bar and check your serial communication settings.

The edit field on the left shows all actual parameters and provides full editing function. The „File“ menu allows to store complete sets of parameters for printout or for download to a counter.

When editing parameters, please use the ENTER key of your PC after each entry, to ensure storage of your data to the counter.

## 8.2. Automatic and Cyclic Data Transmission

Set any cycle time unequal to zero to parameter F09.085.

Set the serial access code of the register you would like to transmit to parameter F09.086. In theory you could transmit any of the internal registers by serial link, however only the following registers make really sense:

<b>F09.086 = 6</b> :	Actual count value of counter 1 (encoder 1)
<b>F09.086 = 7</b> :	Actual count value of counter 2 (encoder 2)
<b>F09.086 = 8</b> :	Actual analogue output voltage (models ZA)
<b>F09.086 = 9</b> :	Latest minimum value from the minimum record register
<b>F09.086 = 10</b> :	Latest maximum value from the maximum record register
<b>F09.086 = 14</b> :	Actual display value as shown on the LED display

Dependent on the setting of parameter F09.084 the unit transmits one of the following data strings, under cycle control of the timer:

(xxxx = counter data\*, LF = Line Feed <hex. 0A>, CR = Carriage Return <hex 0D>)

\*) Leading zeros will not be transmitted

	(Unit No.)											
<b>F09.084 = 0</b> :	1	1	+/-	X	X	X	X	X	X	LF	CR	
<b>F09.084 = 1</b> :			+/-	X	X	X	X	X	X	LF	CR	

## 8.3. Communication Protocol

When communicating with the unit via protocol, you have full read/write access to all internal parameters, states and actual counter values. The protocol uses the DRIVECOM standard according to DIN ISO 1745. A list with the most frequently used serial access codes can be found in the subsequent section.

To request data from the counter, the following request string must be sent:

EOT	AD1	AD2	C1	C2	ENQ
EOT = Control character (Hex 04)					
AD1 = Unit address, High Byte					
AD2 = Unit address, Low Byte					
C1 = Register code to read, High Byte					
C2 = Register code to read, Low Byte					
ENQ = Control character (Hex 05)					

The example shows how to request for transmission of the actual count of counter 1 (register code :6), from a unit with unit address 11:

<b>ASCII-Code:</b>	EOT	1	1	:	6	ENQ
<b>Hexadecimal:</b>	04	31	31	3A	36	05
<b>Binary:</b>	0000 0100	0011 0001	0011 0001	0011 1010	0011 0110	0000 0101

Upon correct request, the counter will respond:

STX	C1	C2	x x x x x x	ETX	BCC
STX = Control character (Hex 02)					
C1 = Register code to read, High Byte					
C2 = Register code to read, Low Byte					
xxxxx = Counter data *)					
ETX = Control character (Hex 03)					
BCC = Block check character					

\*) Leading zeros will not be transmitted

The Block-Check-Character represents the EXCLUSIVE-OR function of all characters from C1 to ETX (both comprised).

To write to a parameter, you have to send the following string:

EOT	AD1	AD2	STX	C1	C2	x x x x x x	ETX	BCC
EOT = Control character (Hex 04)								
AD1 = Unit address, High Byte								
AD2 = Unit address, Low Byte								
STX = Control character (Hex 02)								
C1 = Register code to write, High Byte								
C2 = Register code to write, Low Byte								
xxxxx = Value of the parameter								
ETX = Control character (Hex 03)								
BCC = Block check character								

Upon correct receipt the unit will respond by ACK, otherwise by NAK.

Every new parameter sent will first go to a buffer memory, without affecting the actual counting process. This function enables the user, during normal counting operation, to prepare a complete new parameter set in the background.

To activate transmitted parameters, you must write the numeric value "1" to the "Activate Data" register. This immediately activates all changed settings at the same time.

Where you like the new parameters to remain valid also after the next power up of the unit, you still have to write the numeric value "1" to the „Store EEPROM“ register. This will store all new data to the EEPROM of the counter. Otherwise, after power down the unit would return with the previous parameter set.

## 8.4. Serial Register Codes

### 8.4.1. Communication Commands

Function	Code
Activate Data	67
Store EEPROM	68

These commands have to be sent to the unit every time after one or several new parameters have been transmitted, in order to activate or to store the new values. Both commands are "dynamic", i.e. it is sufficient to just send the data value "1" to the corresponding code position.

Example: send the command "Activate Date" to the counter with Unit No. 11:

ASCII	EOT	1	1	STX	6	7	1	ETX	BCC
Hex	04	31	31	02	36	37	31	03	33

### 8.4.2. Control Commands

To activate control commands (e.g. Reset) by serial link, the following steps are required:

- the desired command has first to be assigned to one of the front keys or control inputs (any), as described in chapter 6.2.6.
- after this the corresponding key or input can be virtually activated by serial command (same as if you would push the key or activate the hardware input). This kind of command provides static operation. Sending "1" to the corresponding location will switch the command ON, it will remain on until you send "0" to the same location to switch the command OFF again.

Control Input / Front Key	Code
Key "UP"	63
Key "DN"	64
Key "Enter"	65

Example: Parameter F06.054 = 1, i.e. input "Cont1" has been configured for "Reset Counter1" (see 6.2.6).

Switch the Reset ON (unit number 11):

ASCII	EOT	1	1	STX	6	9	3	ETX	BCC
Hex	04	31	31	02	36	39	33	03	37

Switch the Reset OFF again (unit number 11):

ASCII	EOT	1	1	STX	6	3	0	ETX	BCC
Hex	04	31	31	02	36	33	30	03	36



Function code "10" (Start Serial Transmission) is incompatible with the serial handling of control commands and will cause communication conflicts

#### 8.4.3. Actual counter data

Nr.	Name	Code
6	Actual count value of counter 1 (encoder 1)	:6
7	Actual count value of counter 2 (encoder 2)	:7
8	Actual analogue output voltage (models ZA)	:8
9	Latest minimum value from the minimum record register	:9
10	Latest maximum value from the maximum record register	;0
14	Actual display value as shown on the LED display	;4

## 9. Specifications

AC power supply	:	24 V~ +/-10%, 15 VA
DC power supply	:	24V- (17 – 40V), approx. 100 mA (+ encoders)
Aux. encoder supply outputs:		2 x 5,2 VDC, 150 mA each 2 x 24V DC, 120 mA each
Inputs	:	2 universal encoder inputs (internal pull-down resistor, Ri = 8.5 kΩ each channel) 4 digital control inputs HTL (Ri = 3.3 kΩ) Low < 2.5 V, High > 10 V, min. pulse width 50 µsec.
Counting frequency (per encoder):		RS422 and TTL differential: 1 MHz (min. differential voltage 1 V) HTL single ended: 200 kHz TTL single-ended: 200 kHz
Switching outputs (all models)	:	4 fast power transistors 5 - 30V, 350 mA <b>(b)</b> Response time < 1 msec. <b>(a)</b> ,
Relay outputs (models ZD6xx, ZA6xx and ZR6xx only)	:	4 relays (dry changeover contacts) <b>(b)</b> AC switching capability max. 250 V/ 1 A/ 250 VA DC switching capability max. 100 V/ 1A/ 100 W
Serial link	:	ZD/ ZA: RS232, 2400 – 38400 Bauds ZR: RS232 and RS485, 2400 – 38400 Bauds
Analogue outputs (models ZA only)	:	0/4...20mA (load max.270 Ohm) 0...+/- 10V (load max. 2 mA) Resolution 14 bits, Accuracy 0.1% Response time < 1 msec. <b>(a)</b>
Ambient temperature	:	Operation: 0 - 45°C ( 32 – 113°F) Storage: -25 - +70°C (-13 – 158°F)
Housing	:	Norly UL94 – V-0
Display	:	6 Digit, LED, high- efficiency red, 15mm
Protection class (front side only)	:	All models without front thumbwheels: IP65 All models with front thumbwheels: IP20 (with plexi-glass cover part # 64026 also IP65)
Protection class rear side	:	IP20
Screw terminals	:	Cross section max. 1.5 mm <sup>2</sup> ,
Conformity and standards:		EMC 2004/108/EC: EN 61000-6-2 EN 61000-6-3 LV 2006/95/EC: EN 61010-1

**(a)** Continuous serial communication may temporary increase response times

**(b)** Diode or RC filtering is mandatory when switching inductive loads



# 10. Dimensions

## Models ZD3xx and ZA3xx:

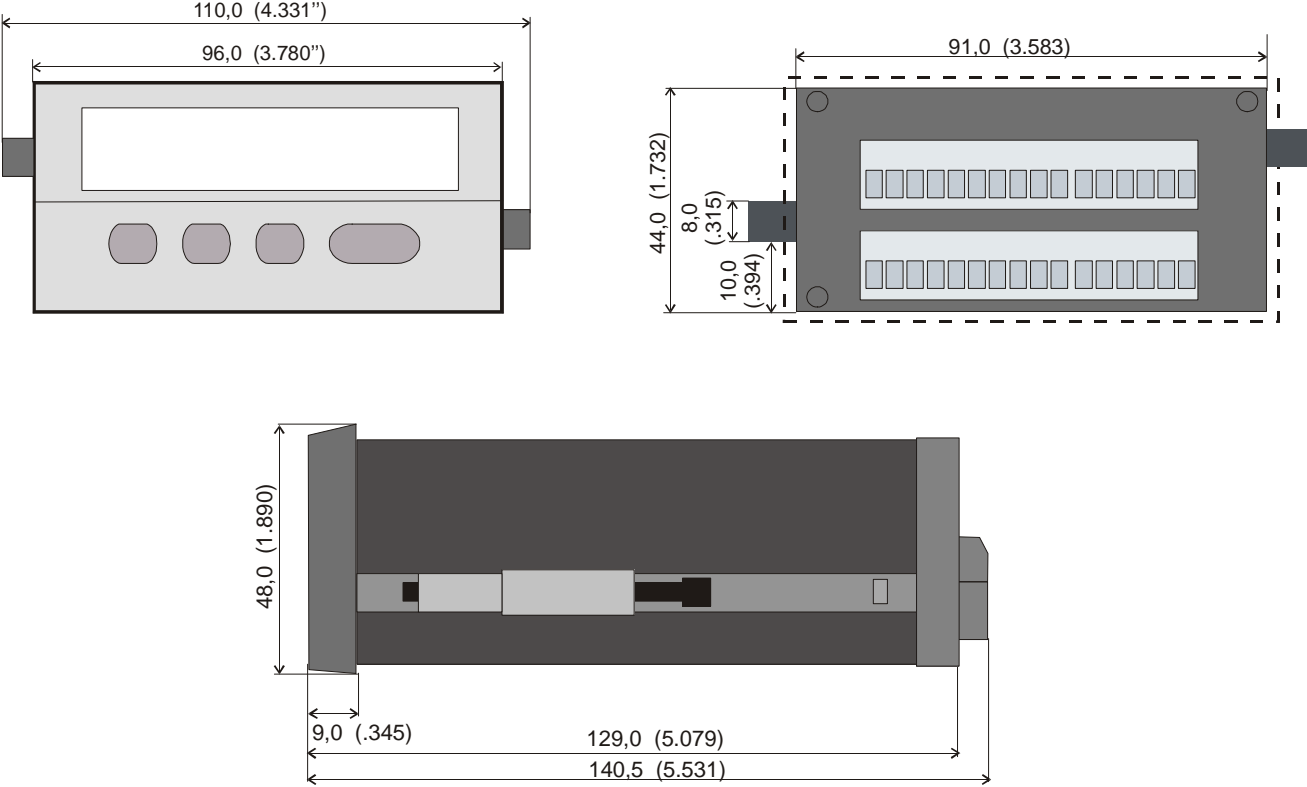

**Panel cut out: 91 x 44 mm (3.583 x 1.732")**

**Models ZD6xx and ZA6xx:**

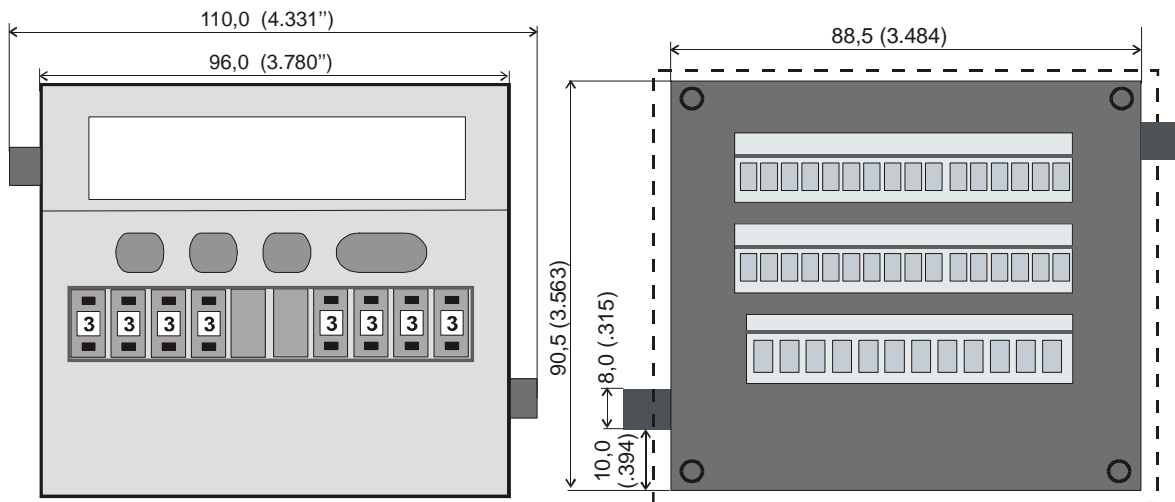

**With optional plexi glass cover  
for protection class IP65  
motrona part # 64026)**

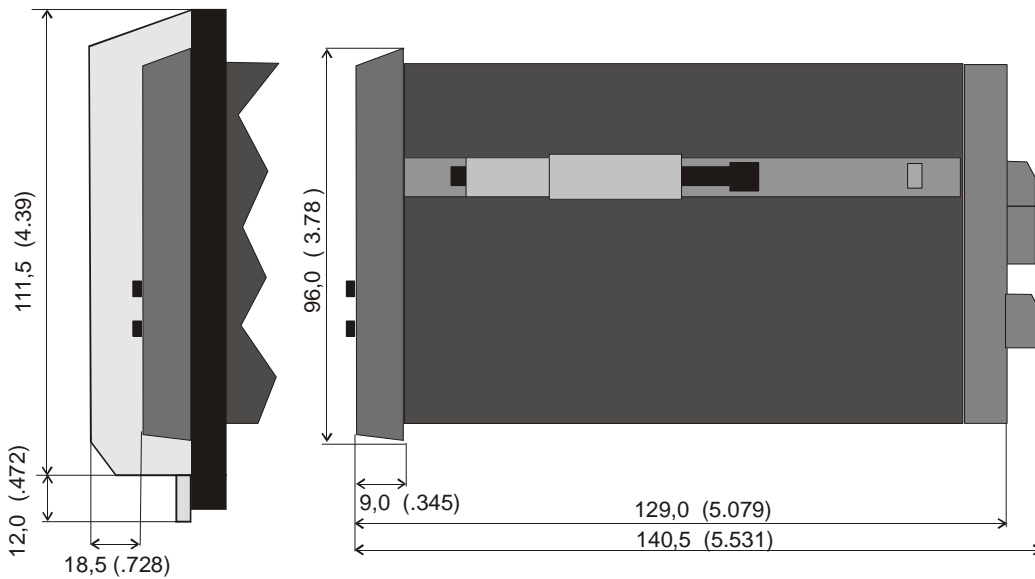

**Panel cut out (w x h): 89 x 91 mm (3.504" wide x 3.583" high)**